



SURF LIFE SAVING®
NEW ZEALAND



EQUIPMENT SPECIFICATIONS

SECTION 12.

SECTION 12.

EQUIPMENT SPECIFICATION MANUAL

IN THIS SECTION YOU WILL FIND:

- EQUIPMENT SPECIFICATION OVERVIEW
- COMPOSITE SURF BOARD (10'6"/3.2m)
- COMPOSITE JUNIOR SURF BOARD (8'10"/2.7m)
- SOFT JUNIOR SURF BOARD (8'10"/2.7m)
- BODY BOARDS
- NIPPER BOARDS
- BOARDS SIZES AND AGE GROUPS
- SINGLE SURF SKI
- DOUBLE SURF SKI
- SURF BOAT
- SURF CANOE
- BATON (Beach Relay/Beach Flags)
- COMMUNICATION AND VIDEO DEVICES ON SLS EQUIPMENT
- FACILITY STANDARDS AND SCRUTINEERING PROCEDURES
- RESCUE MANIKINS
- OBSTACLES
- RESCUE TUBES
- SWIM FINS
- THROW LINES
- RESCUE BRICKS



EQUIPMENT SPECIFICATION MANUAL CONT.

IN THIS SECTION YOU WILL FIND:

SWIMWEAR
HIGH VISABILITY VEST SPECIFICATIONS
BP INFLATABLE RESCUE BOAT (IRB)
PERSONAL FLOTATION DEVICE (PFD)
HELMETS
COMPETITION ARENA EQUIPMENT

SECTION 12.

EQUIPMENT SPECIFICATION MANUAL

12.1. EQUIPMENT SPECIFICATION OVERVIEW

- 12.1.1. The objectives of this manual is to clearly document and make available to all members the specification standards for Surf Life Saving Equipment.
- 12.1.2. This specification manual applies to all SLSNZ clubs and members competing or training on Surf Life Saving equipment within New Zealand.

12.2. COMPOSITE SURF BOARD (10'6"/3.2m):

- 12.2.1. Maximum length – 3.2m (see Figure 3, page 4)
- 12.2.2. Minimum Radii – Nose and Tail in plan view (see Figure 1, page 4) – 25mm
- 12.2.3. Minimum Radii – Leading edge Nose and trailing edge Tail in elevation view (see Figure 3, page 4) – 3mm.
- 12.2.4. Minimum Structural Weight – 7.6kg (includes one fin, plastic/rubber handles and knee/chest pads).
- 12.2.5. Minimum Width – not specified.
- 12.2.6. Only one fin is permitted and must have a minimum profile radius of 25mm at any point, minimum leading edge radius of 3mm and minimum trailing edge radius of 2mm.
- 12.2.7. Leading edge extends from the underside of the board to the lowest point of the fin.
- 12.2.8. Surfboards must contain a minimum flotation in the form of foam or other approved material to provide buoyancy of 20kg mass. If the buoyancy foam used in the manufacturing of the board absorbs water, a permanent sticker must be applied advising the user "if the outer protective layer is pierced the

board will absorb water”.

12.2.9. Surf boards to be of mono construction.

12.2.10. Compliance labels to be secured to the surface of all surfboards manufactured to SLSNZ specifications.

12.2.11. All manufactured/approved surf boards on or after the 1st January 2018 shall be coloured with Hi Vis paint, resin or thermoplastic adhesive film from the tip of the nose and back from the end of the tail to a length of 100mm this can be part of the logo or design. Approved colours include Hi Vis green, black, red, yellow, pink or orange. Where the deck and hull (bottom and top) join an allowance of 10mm disconnect, is acceptable.

12.2.12. Exemptions apply to boards with nose and tail colours in excess of 100mm in green, red, orange, yellow or pink.

12.2.13. Surf board radius specifications:

- (a) Tail side view minimum radius 3mm.
- (b) Tail plan view minimum radius 25mm on both outside edges.
- (c) Nose plan view minimum radius 25 mm on both outside edges.
- (d) Nose side view minimum radius 3mm at tip of nose.

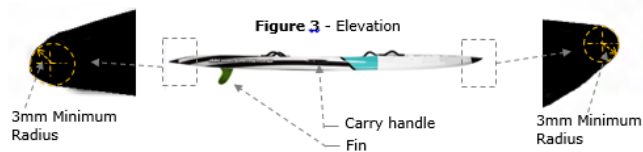
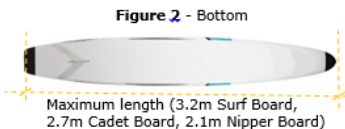
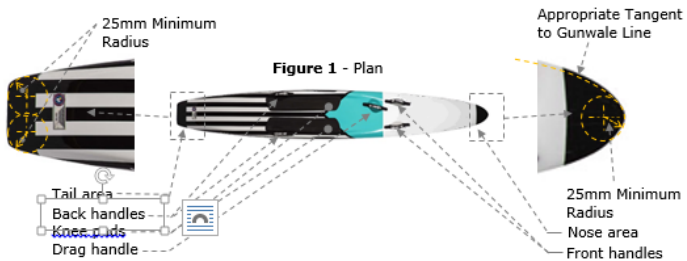

(Images courtesy of Sonic Surf Craft)



12.3. COMPISITE JUNIOR SURF BOARD (8'10"/2.7m):

- 12.3.1. Maximum length – 2.7m (see Fig 2, page 4)
- 12.3.2. Minimum radii – Nose and Tail in plain view (see Fig 1, Page 5 – 25mm)
- 12.3.3. Minimum radii – Leading edge Nose and trailing edge Tail in elevation view 3mm
- 12.3.4. Minimum Structural Weight – 4.5kg (includes one fin, plastic/rubber handles and knee/chest pads)
- 12.3.5. Minimum Width – not specified.
- 12.3.6. Only one fin is permitted. Fin must have minimum profile radius of 25mm at any point, minimum leading edge radius of 3mm and minimum trailing edge radius of 2.5mm. The Leading edge extends from underside of the board to the lowest point of the fin.
- 12.3.7. The board may be constructed of foam sandwich core with a composite laminate skin or of thermoplastic construction solid or hollow with or without a soft foam surface.
- 12.3.8. Surfboards must contain a minimum flotation in the form of foam or other approved material to provide buoyancy of 20kg mass. If the buoyancy foam used in the manufacturing of the board absorbs water, a permanent sticker must be applied advising the user "if the outer protective layer is pierced the board will absorb water".
- 12.3.9. Surf boards to be of mono construction.
- 12.3.10. All newly manufactured/approved Junior Surf Fiberglass Surf Boards on or after the 1st January 2018 shall be coloured with Hi Vis paint, resin or thermoplastic adhesive film from the tip of the nose and back from the end of the tail to a length of 100mm this can be part of the logo or design. Approved colours include Hi Vis green, red, yellow, pink or orange. Where the deck and hull (bottom and top) join an allowance of 10mm disconnect, is acceptable.
- 12.3.11. Exemptions apply to Junior Surf Fiberglass Surf Boards with nose and tail colours in excess of 100mm in green, red, black, orange, yellow or pink.

- 12.3.12. Surf board radius specifications
 - (a) Tail side view minimum radius 5mm.
 - (b) Tail plan view minimum radius 25mm on both outside edges.
 - (c) Nose plan view minimum radius 25 mm on both outside edges.
 - (d) Nose side view minimum radius 3mm at tip of nose.

12.4. SOFT JUNIOR SURF BOARD (8'10"/2.7m):

- 12.4.1. Maximum length – 2.7m (see Figure 2, Page 4)
- 12.4.2. Minimum Nose Radii – Nose and Tail in plan view (see Figure 1, Page 4) – 25mm.
- 12.4.3. Minimum Radii – Leading edge Nose and trailing edge Tail in elevation view (see Figure 3, page 4) – 3mm.
- 12.4.4. Minimum Structural Weight – 4.5kg (includes one fin, plastic/rubber handles and knee/chest pads)
- 12.4.5. Minimum Width – not specified.
- 12.4.6. Durometer hardness – Durometer reading will cover the complete radius of the rail, deck, nose and tail.
- 12.4.7. The Durometer reading is type Shore A, hardness no greater than 70.
- 12.4.8. Only one fin is permitted. Fin must have minimum profile radius of 25mm at any point and minimum leading edge radius of 3mm and minimum trailing edge radius of 2.0mm. The fin is to be of flexible rubber/plastic material or molded foam. The leading edge extends from underside of the board to the lowest point of the fin.
- 12.4.9. The board must be constructed of foam with solid core construction. No solid reinforcing stringers (e.g. fiberglass, wood, etc) are permitted. No hard plastic/fiberglass type coverings over the foam are permitted, i.e., the surface of the craft must be flexible.
- 12.4.10. Plastic/rubber handles and plug attachments are permitted.
- 12.4.11. Boards constructed of Polyethylene or similar flexible

material may incorporate internal stringers to provide rigidity. Such stringers must be adequately covered and approved by the National Scrutineer.

- 12.4.12. Surfboards must contain a minimum floatation in the form of foam or other approved material to provide buoyancy of 20kg mass. If the buoyancy foam used in the manufacturing of the board absorbs water, a permanent sticker must be applied advising the user “if the outer protective layer is pierced the board will absorb water”.

12.5. BODY BOARDS:

- 12.5.1. Minimum length – 70cm
- 12.5.2. Minimum width: not Specified
- 12.5.3. Minimum structural weight: not Specified
- 12.5.4. Durometer hardness – Durometer reading will cover the complete radius of the rail, deck, nose and tail.
- 12.5.5. The Durometer reading is type Shore A, hardness no greater than 70.
- 12.5.6. No fins are permitted.
- 12.5.7. The board must be constructed of foam with solid core construction. No solid reinforcing stringers (e.g. fiberglass, wood, etc) are permitted. No hard plastic/fiberglass type coverings over the foam are permitted, i.e., the surface of the craft must be flexible.
- 12.5.8. All body boards are required to have a leash fitted by the manufacturer that has an adjustable wrist strap and is permanently fixed to the board. The leash length is to be of adequate length to allow standard strokes to be maintained.

12.6. NIPPER BOARDS

- 12.6.1. Maximum length – 2.1m
- 12.6.2. Minimum Nose Radii – Nose and Tail in plan view (see Figure 1, Page 4) – 25mm.
- 12.6.3. Minimum Radii – Leading edge Nose and trailing edge Tail in elevation view (see Figure 3, page 4) – 3mm.
- 12.6.4. Minimum Structural Weight – not specified
- 12.6.5. Minimum Width – not specified.
- 12.6.6. Durometer hardness – Durometer reading will cover the complete radius of the rail, deck, nose and tail.
- 12.6.7. The Durometer reading is type Shore A, hardness no greater than 70.
- 12.6.8. Only one fin is permitted. Fin must have minimum profile radius of 25mm at any point and minimum leading edge radius of 3mm and minimum trailing edge radius of 2.0mm. The fin is to be of flexible rubber/plastic material or molded foam. The leading edge extends from underside of the board to the lowest point of the fin.
- 12.6.9. The board must be constructed of foam with solid core construction. No solid reinforcing stringers (e.g. fiberglass, wood, etc) are permitted. No hard plastic/fiberglass type coverings over the foam are permitted, i.e., the surface of the craft must be flexible. Note: Plastic/rubber handles and plug attachments are permitted.
- 12.6.10. Boards constructed of Polyethylene or similar flexible material may incorporate internal stringers to provide rigidity. Such stringers must be adequately covered and approved by the National Scrutineer.
- 12.6.11. Surfboards must contain a minimum floatation in the form of foam or other approved material to provide buoyancy of 20kg mass. If the buoyancy foam used in the manufacturing of the board absorbs water, a permanent sticker must be applied advising the user “if the outer protective layer is pierced the board will absorb water”.

12.7. BOARDS SIZES AND AGE GROUPS:

12.7.1. Body Boards (Reference 4.0)

- (a) Age: All age groups
- (b) Division: All Division
- (c) Minimum Length: 27" / 70cm
- (d) Minimum Width: not Specified
- (e) Max Weight: not Specified

12.7.2. 6'6" Nipper Boards (Reference 4.0)

- (a) Age: All age groups
- (b) Division: All Divisions
- (c) Max Length: Up to 6'6" / 2.1m
- (d) Max Width: not Specified
- (e) Minimum Weight: not Specified

12.7.3. 8'10" Cadet Boards (Reference 2.0 & 3.0)

- (a) Age: 9 – 11 Years
- (b) Division: Under 10, Under 11, Under 12
- (c) Max Length: Up to 8' 10" / 2.7m
- (d) Max Width: not Specified
- (e) Minimum Structural Weight – 4.5kg (includes fin, handles and foam Knee Pads).

12.7.4. 10'6" Composite Board (Reference 1.0)

- (a) Age: 12 Years +
- (b) Division: Under 13 to Open and Masters
- (c) Max Length: Up to 10' 6" / 3.2m
- (d) Max Width: not specified.
- (e) Minimum Structural Weight – 7.6kg (includes one fin, plastic/rubber handles and knee/chest pads).



10'6" Composite Surf Board 10'6" Composite Rescue Board 8'10" Composite Cadet Board 8'10" Soft Cadet Board 6'6" Soft Nipper Board

(Image courtesy of Sonic Surf Craft)

12.8. SINGLE SURF SKI:

12.8.1. Maximum length 5.79 m (includes wave deflector – not including any rudder).

12.8.2. Minimum structural weight

- (a) 18kg (excludes removable deflector, includes all rudders and mechanism, rudder pedals and cables, all flexible foot straps, adjustable foot blocks and mechanism, pedals and seat pads, fixed fins, hatch covers and starting handles).
- (b) Ski structural laminate construction must not contain more than 1 layer of 225 gm E glass CSM (except where reinforced patches are required) all other layers must consist of stitched fabric or woven fabric of E, S or R glass, carbon fibre or Aramid fibre.
- (c) Core materials maybe used provided they do not absorb water.
- (d) Gel coat must be a NPG Isophthalic ,NPG orthophthalic or Isophthalic with high UV protection.
- (e) A Ski can lose weight after manufacture, if weight loss is less than 250gms the weight maybe replaced with permanent material provided the material is fixed to the craft e.g. Thermoset resin. Greater weight loss MUST be reported to SLSNZ and the manufacture. The craft cannot

be used within surf lifesaving until the weight is to the specification (18 kg).

12.8.3. Ski's to be of mono construction.

12.8.4. Compliance labels to be secured to the surface of all Ski's manufactured to SLSNZ specifications.

12.8.5. Minimum width.

- (a) Shall be 480mm, measured at the widest point of the hull and exclude any rubbing strips, mouldings, additional protective mouldings or edge of rollover decks.
- (b) If they are incorporated in the ski, the measurement will be taken from the underside of the hull at the widest point excluding all rubbing strips, additional protective mouldings or rollover decks and shall have a minimum width of 480mm.
- (c) Minimum width at a point 400mm from the bow shall be 180mm.
- (d) Minimum width at a point 200mm from the bow shall be 75mm.

12.8.6. Where a build in deflector greater than 400mm in length is used, the minimum width 400mm from the bow shall be measured as detailed in Item 6.5, c.

12.8.7. Where the deck and/or gunwale is raised in a manner which increases the width of the hull, the minimum width of 480mm is required to occur at a point on the underside of the hull on a line which represents the true line of the gunwale.

12.8.8. Reverse Curve

- (e) Reverse curve is permitted in the hull to provide greater lift and shall be built according to the following data.
- (f) Reverse Curve is permitted in hull only between forward edge of foot wells and bow of ski
- (g) The maximum depth of the reverse curve shall be 20mm measured over 130mm span. Width of span to be measured from deck line when removable deflector or built-in deflector less than 400mm in length is used.
- (h) The maximum reverse curve width shall be measured at a point 400mm from the bow of the ski and will reduce to no

reverse curve at a point to the front of the forward edge of foot wells.

- (i) When a built in deflector longer than 400mm is used the method following shall be used to measure the 180mm and 75mm minimum width of the hull. From the underside of the ski any deflector length in excess of 400mm shall be disregarded and the measurement taken from the 400mm point.
- (j) An approved SLSNZ template 180mm wide shall be placed against the underside of the ski, 400mm from the bow of the ski. Adjustable straight edges, fitted to the template, 130mm long shall be moved to touch the hull of the ski and check made to ensure reverse curve to such straight edges do not exceed 20mm each side.
- (k) No reverse curve in any direction is permitted in the hull between the front foot straps and the stern of the ski.
- (l) When repairs or manufacture result in a reverse curve being created the ski should be filled and faired to remove the reverse curve.

12.8.9. Component Specifications

- (a) Deflectors (removable or built-in): Wave deflectors shall not be wider than maximum width of ski.
- (b) Minimum edge radius shall be 3mm in elevation and in plan; deflectors shall have a minimum radius of 25mm.
- (c) Rudders: Rudder blades shall be of composite material or other approved material. Rudders must have a minimum profile radius of 25mm, except at the hull, minimum leading edge radius of 3mm and minimum trailing edge radius of 2mm. Leading Edge extends from the underside of the hull to the lowest point of the rudder. Any fixed fin must also conform to this clause.
- (d) Rudder Mechanisms: There must be no projection of the rudder mechanism, e.g., balls, screws, pins or rods etc that could cause injury or damage. A plastic cover shall protect all rudder cables made of stainless steel.
- (e) Foot wells and seating wells shall be incorporated in the overall construction and be completely sealed from the hull.

- (f) Adjustable foot blocks/straps may be used. Mechanism used in the adjustment must be approved and have no projections or sharp edges that can cause injury.
- (g) All foot straps MUST incorporate an approved centre release system.
- (h) All ventures protruding from the hull must have a minimum of 1.5mm radius on all exposed edges and be designed so no leading edge can cause injury due to wear through use. They must be constructed of plastic, rubber or composite. The use of metal ventures is not permitted.
- (i) Flotation: Single skis shall contain a minimum flotation in the form of foam or other approved material to achieve 30kg of positive buoyancy.
- (j) Flotation foam must not absorb water. If polystyrene is used the surface must be sealed.

12.8.10. All manufactured/approved Single Surf Skis after the 1st January 2018 shall be coloured with Hi Vis paint, resin or thermoplastic adhesive film from the tip of the nose and back from the end of the tail to a length of 100mm this can be part of the logo or design. Approved colours include Hi Vis green, black, red, yellow, pink or orange. Where the deck and hull (bottom and top) join an allowance of 10mm disconnect, is acceptable.

12.8.11. Exemptions apply to Single Surf Skis with nose and tail colours in excess of 100mm in green, red, pink, yellow, or orange.

12.8.12. Design: Minimum measurements along the hull from a flat horizontal surface require are as follows:

- (a) 75mm at stern to underside, which will be the general continued curvature line of the hull.
- (b) 300mm at bow along true line of gunwale. (Deflectors are not considered a part of a true line of the gunwale and should not be included in the measurement).
- (c) At 600mm in from stern, a clearance of 50mm.
- (d) At 100mm in from bow, a clearance of 200mm.
- (e) At 400mm in from bow, a clearance of 75mm.
- (f) A single ski less than the maximum length of 5.79 metres

must still comply with the measurements from bow and stern – for the curvature check.

12.8.13. For measuring:

- (a) The ski must sit on SLSNZ's standard jig and touch or clear all jig measurements, keeping within the overall length.
- (b) For skis, less than the minimum length the jig must be adjusted to the length of the ski.
- (c) There must be no reverse curvature of the bottom of the ski from the bow to the line of the SLSNZ's standard jig.
- (d) As a safety precaution, minimum profile of hull/deck at tail and bow (where removable deflector is used) of skis in either plan or side elevation shall be 25mm. Minimum radii in other directions to be 4mm. Further minimum radii of V bow to be 4mm.
- (e) Projection of the overlapping deck past the hull at tail (and bow) to not exceed 5mm.
- (f) If a deck is less than 25mm deep at the join, the 25mm radius must extend to 25mm depth minimum.

12.8.14. Ski Paddles.

- (a) Currently no specification for paddles exists. However, all paddles must be free of sharp or jagged edges (which may cause injury).

12.8.15. Carrying handles may be attached to the skis such handles are not to cause injury and are approved by scrutineers.

Figure 1 - Plan

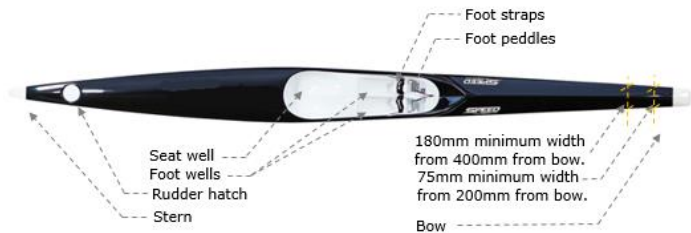

Figure 2 - Bottom



Figure 3 - Elevation



(Images courtesy of Sonic Surf Craft)

12.9. DOUBLE SURF SKI:

12.9.1. Maximum length - 7.32 m (Includes wave deflector – not including any rudder)

12.9.2. Minimum structural weight

12.9.3. 32kg. (Excludes removable deflector), includes all rudders and mechanism, rudder pedals and cables, all flexible foot straps, adjustable foot blocks and mechanism, pedals and seat pads, fixed fins, hatch covers and starting handles).

12.9.4. Ski has to be of mono construction.

12.9.5. Compliance labels to be secured to the surface of all Ski's manufactured to SLSNZ specifications

12.9.6. Ski structural laminate:

- (a) Construction must not contain more than 1 layer of 225 gm E glass CSM (except where reinforced patches are required) all other layers must consist of stitched fabric or woven fabric of E, S or R glass, carbon fibre or Aramid fibre.
- (b) Core materials may be used provided they do not absorb water.
- (c) Gel coat must be a NPG Isophthalic, NPG orthophthalic or Isophthalic with high UV protection.
- (d) A Ski can lose weight after manufacture, if weight loss is less than 250gms the weight maybe replaced with permanent material provided the material is fixed to the craft e.g. Thermoset resin. Greater weight loss MUST be reported to SLSNZ and the manufacture. The craft cannot be used within Surf Life Saving until the weight is to the specification (32 kg.)

12.9.7. Minimum width:

- (a) 580mm measured at widest point of hull and shall not include rubbing strips, mouldings, additional protective moulding or edges of rollover decks.
- (b) If they are incorporated in the ski'. The measurement will be taken from the underside of the hull at the widest point excluding all rubbing strips, additional protective mouldings or rollover decks and shall have a minimum width of

580mm.

- (c) Where rubbing strips, mouldings, additional protection mouldings or rollover decks are used the minimum width of the hull measured at the underside of such strip; moulding or rollover deck shall be 580mm.
- (d) Minimum width at a point of 400mm from the bow shall be 180mm.
- (e) Minimum width at a point of 200mm from the bow shall be 75mm.
- (f) The deck shall be continuous from the front of the footwall to the bow and shall not deflect down 400mm from the bow. This will apply to all new models, (does not apply to existing models in production) from the issue date of the new specifications.
- (g) When a built in deflector longer than 400mm is used the following method shall be used to measure the 180mm and 75mm minimum width of the hull. From the underside of the ski any deflector length in excess of 400mm shall be disregarded and the measurement taken from the 400mm point.
- (h) Where the deck and/or gunwale is raised in a manner which increases the width of the hull the minimum width of 580mm is required to occur at a point on the underside of the hull on a line which represents the true line of the gunwale.
- (i) Where rubbing strips, moldings, additional protection moldings or rollover decks are used the minimum width of the hull measured at the underside of such strip; molding or rollover deck shall be 580mm.

12.9.8. Reverse curve:

- (j) is permitted in hull to provide greater lift and shall be build according to the following details:
- (k) Reverse curve is permitted in hull only between forward edge of front foot wells and bow of ski.
- (l) The maximum depth of the reverse curve shall be 20mm measured over a 130mm span. Width of span to be measured from deck line when removable deflector or built in deflector less than 400mm in length is used.

- (m) The maximum reverse curve width shall be measured at a point 400mm from the box of the ski and will reduce to no reverse curve at a point to the front of the forward edge of foot wells.
- (n) When a ski has a built-in deflector longer than 400mm is used the following method shall be used to measure the 180mm minimum width of the hull [Clause 9.10 and maximum reverse curve Clause 9.11(ii)].
- (o) An approved SLSNZ template 180mm wide shall be placed against the underside of the ski, 400mm from the bow of the ski. Adjustable straight edges fitted to the template 130mm long shall be moved to ensure reverse curve to such straight edges do not exceed 20mm each side.
- (p) No reverse curve, in any direction, is permitted in the hull between the front foot straps and stern of the ski.
- (q) If repairs or manufacture result in a reverse curve being created, the ski should be filled and faired to remove the reverse curve.

12.9.9. Component Specification

- (a) Deflectors (removable or built-in): Wave deflectors shall not be wider than maximum width of ski. Minimum edge radius shall be 3mm in elevation and in plan deflectors shall have a minimum radius of 25mm

12.9.10. Rudders:

- (a) Rudder blades shall be of composite material or other approved material. Rudders must have a minimum profile radius of 25mm, except at the hull, minimum leading edge radius of 3mm and minimum trailing edge radius of 2mm.
- (b) Leading Edge extends from the underside of the hull to the lowest point of the rudder. Any fixed fin must also conform to this clause.
- (c) There must be no projection of the rudder mechanism, e.g., balls, screws, pins or rods etc that could cause injury or damage. A plastic cover shall protect all rudder cables made of stainless steel.
- (d) Rudders: Rudder blades shall be of composite material or other approved material. Rudders must have a minimum profile radius of 25mm, except at the hull, minimum leading

edge radius of 4mm and minimum trailing edge radius of 2.0 mm.

12.9.11. Foot wells and seating wells.

- (a) Shall be incorporated in the overall construction and be completely sealed from the hull.
- (b) Adjustable foot blocks/straps may be used. Mechanism used in the adjustment must be approved and have no projections or sharp edges that can cause injury.
- (c) All foot straps must incorporate an approved centre release system.

12.9.12. Flotation:

- (a) Double skis shall contain a minimum flotation in the form of foam or other approved material to achieve 30kg of positive buoyancy.
- (b) Flotation foam must not absorb water. If polystyrene is used the surface must be sealed.

12.9.13. All manufactured/approved Surf Double Skis after the 1st January 2018 shall be coloured with Hi Vis paint, resin or thermoplastic adhesive film from the tip of the nose and back from the end of the tail to a length of 100mm this can be part of the logo or design. Approved colours include Hi Vis green, black, red, yellow, pink or orange. Where the deck and hull (bottom and top) join an allowance of 10mm disconnect, is acceptable.

12.9.14. Exemptions apply to Double Surf Skis with nose and tail colours in excess of 100mm in green, black, red, orange, yellow or pink.

12.9.15. All ventures protruding from the hull must have a minimum of 1.5mm radius on all exposed edges and be designed so no leading edge can cause injury due to wear through use. They must be constructed of plastic, rubber or composite. The use of metal ventures is not permitted.

12.9.16. Design:

- (a) Minimum measurements along the hull from a flat horizontal surface required are:
- (b) 75mm at stern to underside, which will be the general

continued curvature line of the hull.

- (c) 300mm at bow along true line of gunwale (deflectors are not considered a part of a true line of the gunwale and should not be included in the measurement).
- (d) At 600mm in from stern, a clearance of 50mm.
- (e) At 100mm in from bow, a clearance of 200mm.
- (f) At 400mm in from bow, a clearance of 75mm.
- (g) A double ski less than the maximum length of 7.32 metres must still comply with the measurements from bow and stern – for the curvature check.

12.9.17. Measuring:

- (h) The ski must sit on SLSNZ's standard jig and touch or clear all jig measurements, keeping within the overall length. For skis, less than the minimum length the jig must be adjusted to the length of the ski.
- (i) There must be no reverse curvature of the bottom of the ski from the bow to the line of SLSNZ's standard jig.
- (j) As a safety precaution, minimum profile of hull/deck at tail and bow (where removable deflector is used) of skis in either plan or side elevation shall be 25mm. Minimum radii in other direction to be 4mm.
- (k) Further minimum radii of V bow to be 4mm.
- (l) Projection of overlapping deck past the hull at tail (and bow) to not exceed 5mm.
- (m) If a deck, overlap is less than 25mm deep at the join the 25mm radius must extend to 25mm depth minimum.

12.9.18. Ski Paddles:

- (a) Currently no specification for paddles exists, however all paddles must be free of sharp or jagged edges (which may cause injury).

12.9.19. Carrying handles may be attached to the skis provided such handles are not to cause injury and are approved by scrutineers.

Figure 1 – Plan

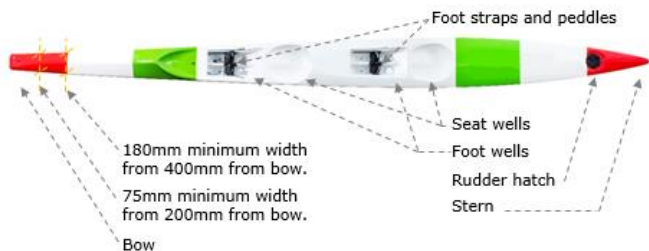

Figure 2 – Bottom

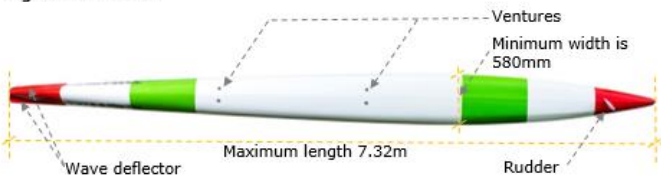

Figure 3 - Elevation



(Images courtesy of Sonic Surf Craft)

12.10. SURF BOAT:

12.10.1. General

- (a) Boat manufacturers commencing construction of composite foam sandwich boats for the first time shall submit a test panel as directed by the national surfboat adviser of the proposed layup, with full details to SLSNZ the national surfboat adviser.
- (b) Any proposed changes or alternatives to approved layups, stiffening or construction shall be submitted prior to construction, along with supporting professional engineering calculations and advice, for the consideration and approval of the hon. National surf craft / surf boat advisor. As a minimum requirement, the layups shall be at least as strong (eg. Equal or greater reinforcement fabric weight and improved fibre orientation) as the presently approved layups in the specification.
- (c) All components and items listed in hull construction (clause 8.3.) shall be fitted to the boat unless described as advisory or where an otherwise SLSNZ approved alternative is allowed.

12.10.2. Dimensions

- (a) Length overall – minimum 6.86m to a maximum 7.925m (not including the sweep outrigger).
- (b) Beam – minimum of 1.62m between projections of outside hull at top of gunwale, measured at widest midship section near to nos. 2 or 3 thwart; see also clause 6.2.4.
- (c) Moulded depth – minimum of 558mm from top of gunwale to lowest part of outside hull at keel, measured at the same section as the beam measurement.
- (d) Hull reverse curvature – any reverse curvature of the hull, between the stern and a point 3.04m from the bow shall be limited to a maximum of 13mm, measured between gunwale and keel. Where the gunwale has been moulded, or where the outside hull at top of the gunwale is otherwise hard to measure, the reverse curvature may be measured by placing a straight edge batten over the hull with the top end of the straight edge within 5mm of the gunwale. A projection of the straight edge to the top of the gunwale

must also comply with minimum beam measurement requirements of clause 8.2(b).

- (e) Longitudinal hull profile – minimum hull depths and the minimum profile, relative to the baseline at a maximum of 57mm from the hull at midships, shall be in accordance with the dimensions given in figure 1. The gunwale and keel centre line at hull profiles shall each maintain a smooth and continuous curve.

12.10.3. Hull construction

- (a) Construction materials – wherever the words ‘suitable or approved timber’ are mentioned they shall refer only to one of the species allowed in the specification and shall be suitable for the particular purpose. Similarly, for grp (e-glass fibre reinforced plastic) and closed-cell foam core materials the type and minimum weights/densities shall be as specified or otherwise approved by the slsnz. Adhesives used shall be either urea, resorcinol, melamine, methacrylate (plexus, weldon etc.) Or epoxy and shall be a gap filling, marine grade, suitable for the particular purpose.
- (b) Resins used shall be marine grade, suitable for the particular purpose and the resin to glass fibre ratio shall typically be 2:1 by weight for csm (chopped strand mat) and cfm (continuous filament mat for vacuum resin infusion) and 1:1 (hand-layup) or 0.7:1 (vacuum resin infusion) by weight for e-glass stitched non-crimp non-woven reinforcement fabrics. That is, for optimum strength the percentage of glass fibre content shall be matched to the reinforcement style in recognition of best practice.
- (c) The use of resin only, without fibre reinforcement, to build up structure or to add hull weight is not permitted.

12.10.4. Fastenings and fittings

- (a) The fastenings shall be as specified, or of marine grade composition, suitable for the particular application from the following metals: astm 316 stainless steel, monel metal, silicone bronze, aluminium bronze or copper. The use of brass, steel or plated steel fasteners is not permitted, with exception of brass in electrical circuit fastenings only.

- (b) Brass or steel shall not be used for any fittings unless specifically allowed in the specification.
- (c) All fittings and fastenings shall be installed ensuring that there are no dangerous protruding, sharp edges or screw threads.

12.10.5. Foam sandwich hull

- (a) Core material – core material shall be an approved pvc or san foam (presently approved products are klegecell, airex, divinycell and corecell).
- (b) The minimum manufacturer's nominal sheet density shall be 70kg/m³.
- (c) The minimum nominal thickness shall be 12mm in hulls and generally 10mm in decks (6mm in fore and aft cover decks and bulkheads).

12.10.6. Skin material

- (a) The type of fibre in the reinforcement fabrics used shall be conventional e-glass and resin in the laminate must be marine grade polyester or vinylester containing styrene and suitable for the purpose.
- (b) Resin used in the vacuum infusion process shall be specifically formulated for this process.

12.10.7. Basic hull shell layup

- (a) The outside grp sandwich skin laminate shall have a minimum of 675g/m² dry fibre. The layup shall include a minimum 225g/m² csm (chopped strand mat) as a tie/skin coat behind the gelcoat..
- (b) The inner grp sandwich skin laminate shall have a minimum of 450g/m² of dry fibre. Basic deck shell layup shall comprise a minimum of csm – 225g/m² either side of 10mm foam core.

12.10.8. Multi-layers of woven cloth

- (a) Should multi-layers of woven reinforcement be used anywhere in the construction of the hull or fittings, a layer of csm (e.g. 225g/m²) shall be placed between each layer of cloth. This provision does not apply if the vacuum infusion process is used in the layup of the hull or deck shells.

12.10.9. Connection of layup skins

- (a) The inner and outer skins shall be solidly connected or joined at the gunwale by excluding the foam core or replacing it with a suitable high-density core.
- (b) The core material shall be continuous from gunwale to gunwale, or shall be divided at the centre line of keel with skins fixed to, or integral with, the full internal keel in one of the following ways, or otherwise as only approved by slsnz:
 - (i) the foam core shall cease 50mm from each side of centreline;
 - (ii) the edge of the foam next to centre line shall be chamfered on its inner edge at a minimum taper of 1:1;
 - (iii) the inside skin shall join the outside skin at the bottom of the chamfered edge and overlap the centre line a minimum of 50mm;
 - (iv) the internal keel shall be bonded to the lapped skins using epoxy adhesive, or,
 - (v) a timber spacer, 50mm x 12mm section shall be shaped and laid full length to fit outside skin along the keel line, and effectively glued using epoxy adhesive;
 - (vi) the foam core shall be laid hard up to the edge of the timber spacer and the inside skin laid over foam and the timber spacer;
 - (vii) the internal keel shall be glued to the inside skin over the top of the keel line timber spacer using epoxy adhesive; or,
 - (viii) the internal keel shall be effectively glued to the outside skin using an epoxy adhesive;
 - (ix) the foam core shall be laid hard up to the internal keel on each side;
 - (x) the inside skin shall be laid over the foam core and internal keel in a continuous run.
- (c) Single skin glass reinforced plastic (grp) hull. Refer to oct 10, 2002 specification. Builders of single-skin frp boats use oct 10, 2002 rule, ILS.
- (d) Timber sandwich hull. Refer to oct 10, 2002 specification.

Builders of timber/timber-sandwich boats use oct 10, 2002 rule of the ILS.

12.10.10. Scantlings, stiffening and strengthening

- (a) all “timbers”, including stringers, risers and gunwales, where used, shall be full length, straight grained, approved timber varieties.
- (b) If stringers, risers and gunwales cannot be fitted in one length, the use of scarf joints shall be acceptable with a full taper ratio of minimum 12:1.
- (c) Where specifically allowed in the specification a slsyz approved foam cored grp construction may be used in lieu of timber.

12.10.11. Structural and scantling sizes

- (a) all sizes quoted for timber, other material scantlings and structural components shall be the minimum finished sizes.
- (b) Extreme or unnecessary dressing, scalloping, bevelling or shaping of timbers shall not be permitted. Similar restrictions shall apply to specified sandwich construction alternatives.

12.10.12. Inner gunwale

- (a) The inner gunwale shall be 44mm x 22mm silver ash, mountain ash, yellowwood or white ash efficiently glued to the hull. The dimensions shall be maintained continuously for the length of the boat and shall not be bevelled or scalloped to attach fittings.

12.10.13. Outer gunwale

- (a) The outer gunwale (gunwale mould) shall be 44mm x 22mm silver ash, mountain ash, yellowwood or white ash screwed and glued to the hull and inner gunwale.
- (b) The depth shall be maintained continuously for the total length of the boat and shall not be bevelled to attach fittings. Some shaping of the thickness is permitted forward of the splashboard.
- (c) As appropriate, any end grain hull veneers or soft core material shall be sealed off, for example with a 3mm cover board or a suitable high-density core material.
- (d) The gunwale unit shall not be weakened in the fitting of the

rowlock bosses, etc.

12.10.14. Gunwale strengthening

- (a) Inner gunwales shall be strengthened, underneath or adjacent to rowlock fittings, with 44mm x 19mm timber of the same species as the inner gunwale and shall extend full length between adjacent thwart knees; they may be tapered from the rowlock fitting to the knees or to a minimum of 300mm if the knees are not fitted.
- (b) Alternatively, equivalent strengthening at the bow and stroke rowlocks may be fitted only on the outside of outer gunwale or may be incorporated in outrigger construction.

12.10.15. Foam sandwich gunwales

- (a) Alternatively, the gunwales may be of an approved foam sandwich construction but maintaining the dimensions and profile, and excluding and bevelling or shaping, as per timber gunwales.
- (b) The following are presently approved layouts:
 - (xi) Construction no 1 – the inner and outer gunwale shall each be a minimum of 44mm x 20mm approved foam with a minimum nominal density of 130kg/m³. The grp skin layout shall be a minimum of: - 1000g/m² e-glass fabric or unidirectional rovings
 - (xii) Construction no 2 – the total gunwale is 44mm deep x 50mm wide approved foam with a minimum nominal density of 130kg/m³. The grp skin layout is: - 2 layers of min. 668g/m² triaxial reinforcement fabric
 - (xiii) Construction no 3 – the inner and outer gunwales are each 55mm deep x 25mm wide approved foam with a minimum density of 130kg/m³. The grp skin layout is: Unidirectional roving 500g/m² (fore & aft) 2 layers woven fabric 330g/m² each.

12.10.16. Stringers and seat risers

- (a) Stringers and seat risers, when used shall be 32mm x 19mm approved timber (extending from stem to stern) glued to contacting surfaces.

- (b) Timbers approved are: silver ash, yellowwood, spruce, oregon, alpine ash, coachwood, celery-top pine, hoop pine, huon pine, myrtle beech, queensland maple, select spotted gum.
- (c) A foam core with grp skin of the same layup as the hull may be used in lieu of timber in stringers and seat risers.

12.10.17. Stringers in single skin grp hulls

- (a) Hulls of solid grp construction shall have a minimum of two full-length stringers (stiffeners).
- (b) If a buoyancy insert or tanking is used, its construction may be incorporated with the hull stringers which shall maintain continuity end to end.

12.10.18. Internal keel

- (a) A full length internal keel shall be fitted using oregon, spruce, celery-top pine or huon pine and the unshaped size shall be 98mm x 31mm; if silver ash, mountain ash, alpine ash or white ash the unshaped size shall be 76mm x 31mm; or if a foam box section is used the unshaped core size shall be 98mm x 36mm which shall be fully encased in a grp skin.
- (a) An alternative approved construction is, when using full length buoyancy tank inserts, the longitudinal bulkhead verticals are considered to replace the role of the box section internal keel, providing: (a) the verticals are fully glassed and within 180mm of the centre line; (b) a minimum of 75mm of each side of each vertical is additionally glassed with min. 300g/m² reinforcement fabric each side and adequately glassed to the hull; (c) the reinforcement component in the normal lapped hull skin layup between the verticals is increased by a minimum of 40%; and (d) the lapped hull layup must be adequate to support the external false keel and connections.

12.10.19. External false keel

- (a) A full length external keel shall be glued and/or screwed to the internal keel over the lapped hull layup using 38mm x 19mm silver ash, yellowwood or alpine ash.
- (b) The false keel may be shaped from 38mm down to 19mm at the keel rubbing band and the depth may be evenly

tapered from 19mm to 6mm over the aft 1.8m.

- (c) The keel rubbing band shall not include brass in its composition.
- (d) Suitable plastic materials are recommended and metallic bands are generally discouraged for reasons of crew safety.

12.10.20. Deep false keel

- (a) Variations to the above configuration may be permitted if they comply with the following guidelines. The false keel shall be:
 - (i) of minimum length 2m;
 - (ii) placed, as a minimum, between no 2 thwart and the quarter bar;
 - (iii) of maximum depth 75mm;
 - (iv) of minimum single side elevation area 0.10m², i.e., greater than a basic 75mm x 2.67m triangular shape plus an allowance for the concave curvature next to the hull or equivalent area variations;
 - (v) suitably tapered at each end;
 - (vi) fitted with an approved rubbing band extending as a minimum from the bow to the bottom of the stern end of the false keel. The rubbing band is optional from the stern end of the false keel to the stern; and
 - (vii) material may be grp of equivalent layup as hull.

12.10.21. Stem

- (a) The stem shall be reinforced internally with either:
 - (i) A suitable timber insert shaped from 25mm x 36mm section effectively glued to inside of hull: or,
 - (ii) A minimum of two layers of 15mm foam interleaved with two layers of reinforcement fabric similar to hull layup and extending a minimum of 200mm either side; or,
 - (iii) The grp hull layup overlapping at least 200mm either side.

12.10.22. Thwarts

- (a) Thwarts shall be fitted using 178mm x 22mm approved

timber, suitably glued and/or screwed or fiberglass at the seat risers or support blocks. Alternatively, they shall be 178mm x 20mm approved foam and sheathed with same layup as the hull.

- (b) Thwart stanchions – the thwarts shall have stanchions which shall be:
- (i) Of approved timber insert of 125mm x 22mm section effectively glued and or screwed and fastened with shoulder moulds to thwarts and keel to function as both a tie down and support to the thwart. The stanchions may be shaped, provided a minimum of 75% of its original cross-sectional shape is retained; or,
 - (ii) Of approved foam, material with the same layup as hull and effectively glassed to thwarts and keel. The foam stanchion may be constructed as part of a sealed box designed to support the thwart; or,
 - (iii) Alternatively, if the stanchions above are not used the thwarts shall be constructed as an inverted u and be of same thickness and construction as the thwart, with the depth of the downward flanges to be a minimum of 200mm where the flange contacts the inner hull (see figure 2).
- (c) Thwart knees – thwarts shall be fitted with knees by one of the following methods:
- (i) Each thwart shall have four timber knees, blocked and glued to the hull, with three fastenings to the thwart and one through the gunwale. The knees shall be grown tea-tree, plywood or steamed laminates and of 22mm minimum thickness. Copper fastenings (boat nail and roove/burr) through the gunwale may be replaced with 10 gauge screws of approved material, which shall penetrate the outer gunwale a minimum of 10mm; or,
 - (ii) Each thwart shall have central single knees at each end of all thwarts of the above timber or similar sandwich construction as the hull and shall extend from the thwart to near the top of the inner gunwale.

The knees shall be adequately glassed to the inner gunwale, inside hull and the thwart with additional reinforcement extending the full width of the thwarts; or,

- (iii) Each thwart shall have a sandwich foam stiffener of the same width as the thwart at each end. The stiffener shall be of the same thickness as the hull and extend from the thwart to near the top of the inner gunwale, and shall be adequately glassed to the inner gunwale, inside hull and the thwart (see figure 3).
- (d) Extra thwart – an extra thwart shall be fitted between the quarter bar and the stroke thwart by one of the following methods:
 - (i) Of 75mm x 19mm approved timber, strengthened on underside by 38mm x 19mm timber on edge and tapering to the hull or by a 62mm x 19mm stanchion, and shall be fastened to hull with 2 knees similar to thwart knees; or,
 - (ii) Of 62mm x 20mm approved foam and strengthened on underside with 62mm x 20mm approved foam on edge, both with same layup as the outer hull; or,
 - (iii) An approved sealed chamber shaped to the hull may be used with approved knees fastened to the hull as in Figure 3.

12.10.23. Buoyancy tank insert

- (a) A suitable buoyancy tank insert may be moulded and/or fitted inside the hull, also contributing to hull strength, and may incorporate part of the function of the thwarts and stanchions. All such inserts and “liners” generally shall be bonded to the inner surface of the hull shell with similar materials to form a structural connection in at least three locations, two of which are to be the gunwales. The following modifications may then be incorporated.
- (b) Buoyancy tank insert knees – in sandwich construction only, the “thwart” knees/stiffeners may be deleted if complying with all the following conditions:
- (c) A suitable buoyancy tank insert is fitted to the inside hull;

- (d) The insert runs continuously the length of the hull and contributes to boat strength;
- (e) The full thickness sandwich construction hull runs through and between the inner and outer gunwales; and,
- (f) There is suitable reinforcement doubling at the insert/hull interface at the normal thwart/riser height and running the full length.
- (g) Note that knees/stiffeners are still required in all other types of construction.

12.10.24. Insert tank thwarts

- (a) In boats fitted with full-length buoyancy tank inserts, a minimum of three thwarts including the bow shall be fitted. The thwarts shall be of the above specified size and shall be incorporated into insert so that full strength is maintained across the boat, gunwale to gunwale.

12.10.25. Hull decking

- (a) The decking shall be moulded and securely screwed/glued to, and supported by, the gunwales and at least two deck beams of 75mm x 22mm timber or equivalent grp/foam sandwich shall be securely connected to the gunwales. The decking shall be constructed by one of the following methods:
 - (i) 6mm minimum core grp foam sandwich; or,
 - (ii) 5mm ply covered with 3mm timber veneer; or
 - (iii) 2 x 3mm moulded timber veneers to finish not less than 6mm thickness

12.10.26. Buoyancy

- (a) As a safety provision, the boat shall remain buoyant in the damaged condition and/or with inspection hatches missing or open. Buoyancy shall be provided as follows:
- (b) Buoyancy – full foam sandwich hull construction additional buoyancy not required.
- (c) Buoyancy-solid grp hull construction – two units to a total minimum of 0.4m³ of polystyrene foam, or similar material, evenly distributed fore and aft to ensure the boat will float when damaged and full of water. The additional foam shall be used unless demonstrated that sufficient buoyancy

exists.

12.10.27. Coaming

- (a) A coaming shall be provided aft of the forward decking using 10mm timber, moulded or laminated in one piece, to stand 75mm above decking at the centre, or in two pieces fixed to three knees.
- (b) Alternatively, the coaming may be made of grp or foam sandwich of same layup and thickness as the hull.

12.10.28. Tuck

- (a) The tuck stern shall be of same materials used in hull skin and shall be additionally reinforced with a minimum 12mm timber or foam backing or core. Timber may be used as the core material for a sandwich tuck, or as backing for an effectively reinforced solid grp tuck.

12.10.29. Quarter knees to tuck

- (a) Two quarter knees shall be fitted using 22mm sided tea-tree or laminated or moulded plywood. Alternatively, an approved grp lamination may be used.

12.10.30. Breast hooks

- (a) Breast hooks knees shall be fitted using 22mm sided tea-tree or moulded plywood, suitable timber or approved grp or foam sandwich construction moulded to shape of hull.

12.10.31. Sweep outrigger

- (a) The sweep outrigger shall be a minimum 150mm x 50mm silver ash, mountain ash, yellowwood or blue gum securely fixed and glued to deck beams and fastened to the tuck with a 38mm sided knee or metal bracket. Alternatively, the sweep outrigger may be constructed with 150mm x 60mm approved foam, with a minimum density of 130kg/m³, sheathed with a minimum of 1000g/m² of dry reinforcement and glued or glassed to the tuck and deck structure. The outrigger may be tapered down from the tuck to the aft bulkhead.

12.10.32. Quarter bar – the quarter bar shall be shaped from a suitable timber minimum 63mm x 25mm and bolted to the gunwale with maximum 6mm stainless steel bolts; or, glued using epoxy adhesive and fastened each end with 75mm x 10

gauge stainless, monel metal or silicone bronze screws. Alternatively, the quarter bar may be constructed with 60mm a 60mm approved foam, sheathed with a minimum of 1000g/m² of dry reinforcement and glued or glassed to gunwales.

- 12.10.33. Foot-stretchers – foot-stretchers shall be a minimum of 10mm marine ply laminate; or, 20mm approved foam, sheathed with a minimum of 225g/m² of dry reinforcement (e.g. Csm – 225g/m²) ; or, approved equivalent grp construction. These alternatives may be incorporated into the buoyancy tank insert.
- 12.10.34. Keel band – the keel band shall be 19mm, marine grade stainless or approved non-ferrous or synthetic material. Note, this item needs regular inspection to ensure there are no damaged or sharp edges.
- 12.10.35. Rowlock fittings.
- (a) Metal rowlock fittings – the four rowlock fittings shall be fabricated from marine grade stainless steel or monel metal; or cast from marine grade phosphor bronze or similar.
 - (b) The fittings shall fit over the top of the gunwale or approved outrigger gunwale construction and designed so that rowlocks and oars are in the correct position of r rowing.
 - (c) All sharp edges shall be eliminated and corners to top and bottom plates shall have a minimum 10mm radius. Fastening shall be kept to a minimum to avoid weakening of the gunwale.
 - (d) Fabricated fittings shall include a full tubular section for housing the rowlock shaft and the inside of this shank tube shall not extend more than 10mm from a longitudinal line parallel to the widest line of the outer gunwale. Any rowlock fitting may be outriggered to a maximum of this widest line and is called an “outrigger rowlock fitting”.
- 12.10.36. Molded grp rowlock fittings – the rowlock fittings may be incorporated into grp gunwale construction. The dimensions and restrictions shall be as for the metal fittings. The reinforcement fabric layup of the approved grp gunwale shall be increased a minimum of 200% at the fitting, and a suitable synthetic or metal shank tube incorporated into the

construction. Note: this fitting may not be as strong as the metal type.

- 12.10.37.** Outtrigger rowlock fittings – an outrigger rowlock fitting is defined as one where the inside of the shank tube is more than 10mm from the normal outside line of the top edge of the outer gunwale. Outrigged fittings must be additionally protected for safety by a method approved by the hon. National surf craft / surfboat advisor. Approved methods are as follows:
- 12.10.38.** Cover plates. The top and bottom plates of the rowlock fittings shall be fully enclosed with an approved metal cover ensuring that there are no protruding or sharp edges and the fitting shall have a minimum taper of 1:1, fore and aft (see figure 4). This enclosed fitting only may also be used in combination with the outer gunwale outriggered with the approved timber or grp foam sandwich and which shall extend fore and aft with a minimum taper of 1:1.
- 12.10.39.** Protective wedges. Other types of outrigger fittings, if not fully enclosed and/or not tapered correctly, shall be protected, fore and aft, by timber wedges of species approved for gunwales. The wedges shall have a minimum taper of 3:1, and shall extend from the outer gunwale to the inside edge of the shank tube as a minimum, or to the outside edge of the fitting as a maximum. The depth of the wedges shall taper from the full fitting depth, at the fitting, down to the full depth of the gunwale, at the gunwale. The wedges shall be suitably rounded, adequately glued and screwed to the gunwale gaps minimized in the fitting and not exceeding 10mm (see figure 5).
- 12.10.40.** Rowlocks – the rowlocks shall have sufficient spring to allow the oars to be released should they become fouled under the boat. The rowlocks shall also be designed so the oars will slip out when pulled inboard past the leather or synthetic sleeve. The rowlock shank shall not be greater than 16mm diameter, shall not protrude more than 50mm below the rowlock fitting and shall have a hole at the heel for a rowlock retaining pin. The retaining pin shall be manufactured from stainless steel or monel metal and be ring shaped without sharp or protruding ends to prevent injury.
- 12.10.41.** Sweep rowlock – the rowlock shall be manufactured from

stainless steel, monel metal or galvanized steel, may be rounded or goose-necked and bolted through the sweep outrigger rowlock fitting of similar material for rowlock fitting. Nyloc type nuts or a nut with a ring shaped pin shall be used to prevent release and injury.

- 12.10.42. Bungs – drain holes in the hull and/or stern shall have the bungs attached to the boat by nylon cord or non-ferrous chain and screw fittings.
- 12.10.43. Oars – there is no specific specification for surf boat oars. However, for safety the blade shall have a minimum 6mm thickness with no sharp corners at the edges.
- 12.10.44. Rescue tube – an slsnz approved rescue tube shall be fixed to topside of the bow thwart decking or tank top by velcro straps (for quick release).
- 12.10.45. Optional equipment – additional equipment may be fitted or carried on the boat and includes pumps additional grp seats, slsnz approved sliding seats, approved signal plate, signal flags, stainless steel boat or raft knife and buckets. Specific requirements are as follows.
- 12.10.46. Pumps – a maximum of two manual or battery operated pumps of unrestricted capacity may be fitted ensuring that associated piping and fixtures cannot cause injury.
- 12.10.47. Batteries – the batteries used shall be restricted to the fully sealed type and shall be securely attached to the boat in a battery housing of suitable shape and material. The battery housing does not need to be fully enclosed or waterproof; but if the battery is contained in a box, breathing holes shall be provided to dissipate any dangerous gases. Care should be taken when charging the sealed batteries which should be done out of the boat and only using chargers suitable for this type of battery. Note: ordinary car batteries shall not be used. Associated switching and wiring fitted for pumps and batteries shall have no sharp or protruding parts, edges, screws, etc, by design and/or location which could cause injury.
- 12.10.48. Grp seats – grp seat shall be suitably fastened to thwarts or buoyancy tank inserts ensuring that they shall be readily removed for scrutineering and ensuring that there are no gaps,

sharp edges or corners, etc, that could cause injury. If grp seats are incorporated permanently, or are part of the buoyancy tank insert molding and/or the thwart, then a minimum weight allowance of 10kg for the seats shall be added to the minimum allowed weight of the 180kg. (See section 8.50.)

- 12.10.49. Sliding seats – only sliding seats approved by slsnz may be used in normal slsnz competition. Special events, etc, may specifically allow other types. Currently the only slsnz approved sliding seat is the ferrett (south australia) design and manufacture.
- 12.10.50. Weight - the bare weight of the finished craft shall have a minimum weight of 180 kg, with a maximum weight of 190 kg. Final weight excludes all equipment and seats. Finished craft must be signed off by the builder and the purchaser or their designated official
- 12.10.51. Racing weight- the racing weight of the surf boat shall have a minimum weight of 200 kg including seats, pumps and foot blocks. Excludes rowlocks, oars, batteries and any other additions. 8.51 must be read in conjunction with 8.50 (bare weight of hull to have a minimum weight of 180 kg).
- 12.10.52. Specification binding
- (a) All SLSNZ clubs, and compliant boat manufacturers shall accept this specification, along with official amendments and relevant bulletins, as a condition of the boats use and manufacture. All clubs and competitors have a responsibility to ensure that their boats maintain compliance to the specifications.
 - (b) It shall be understood as a part of the condition of manufacture or use, that the slsnz shall reserve the right to direct the removal of a core sample from the boat and submit that core for analysis and testing if, in the opinion of the slsnz, there is reason to suspect that the grp, foam or timber sandwich construction does not conform to the specification.
 - (c) Should a dispute arise in relation to any aspect of this specification then the national sport shall, after consultation with the appropriate parties, arbitrate on the matter and

whose decision shall be binding.

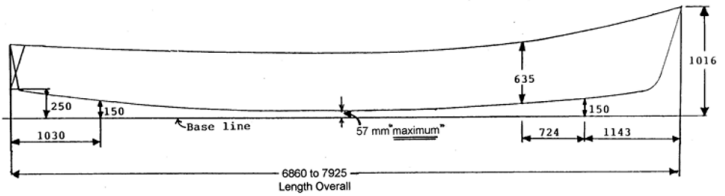

Figure 1. Surf Boat Minimum Allowable Profile Measurements (mm)

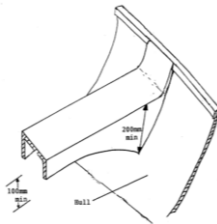

Figure 2. Inverted U Shaped Thwart

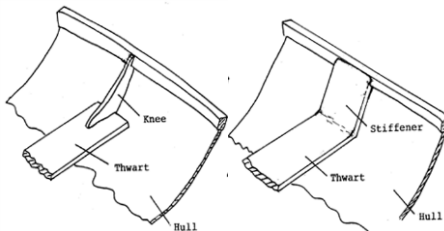

Figure 3. Single Thwart Knee or Alternative Stiffeners

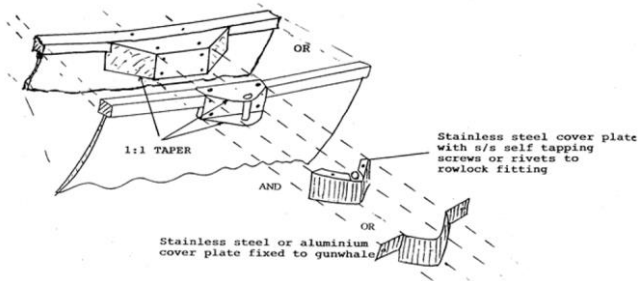
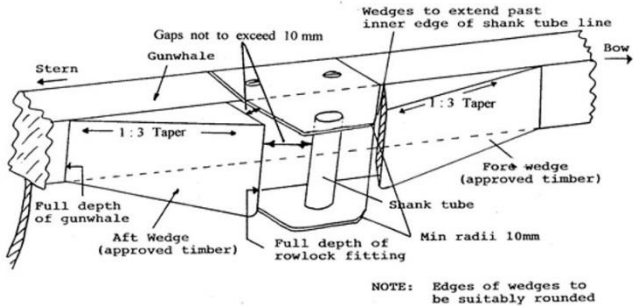

Figure 4. Rowlock Fittings Approved Covers



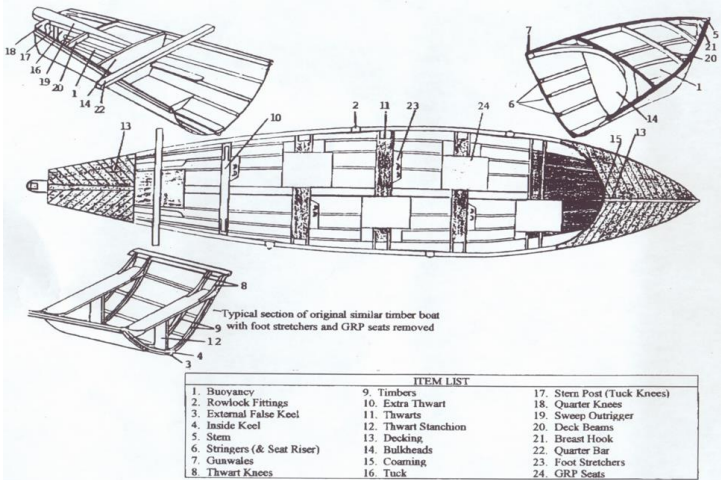

Figure 6. Sections of Boat and Item List

12.11. SURF CANOE:

12.11.1. Measurement Specifications

- (a) Length Over All (Loa) - Minimum 5.5 m / maximum 6.5 m. Loa is measured from forward most point of bow to after most point of transom (not including rudder or gudgeons)
- (b) Beam - Minimum 1.1m / maximum 2.2 m
- (c) Depth - Depth of canoe measured at the widest point from the gunwhale height to the keel to be a minimum of 350mm.

12.11.2. Constructions Requirements

- (a) Splash Guard (Single Hull Canoes Only) - Splash guard shall be a minimum of 80mm above the forward deck for a distance equal to 80% of the beam measurement.
- (b) Buoyancy Chambers - There should be three separate buoyancy chambers each with minimum capacity of 100 litres for single hull canoes. For cats, each hull shall form a buoyancy chamber with closed cell foam providing the buoyancy.
- (c) Seating - To be incorporated in such a way that the craft can be paddled by a crew seated 2x2 abreast.
- (d) External protrusions - Zero external protrusions to the hull i.e. Skegs fins or keels (safety issue).
- (e) Outrigger Poles - Where outrigger poles are used in the case of a 'cat' the minimum diameter of the poles should be at least 50mm dia stainless steel or other material such as aluminum or carbon fibre provided they have no less structural integrity.

12.11.3. Operative Equipment

- (a) Rudder - When in its normal operating position no part of the rudder shall extend more than 350mm from the aft face of the transom or back strut. No part of the rudder shall protrude outside of the imaginary extension of the hull aft of the transom. The rudder blade must be free at all times to retract to within the same imaginary extension of the hull. The rudder blade must not be pinned down.
- (b) Rudder Control - Steering cable or rods must be concealed in a safe and secure manner (e.g. Inside of conduit or

bulkhead) to within 300mm of foot pedals.

- (c) Bilge Pump (Single Hull Canoes Only) - The fitting of two pumps of unlimited capacity (per canoe) are permitted. Batteries are to be dry cell or lead acid gel fully sealed. Pumps and battery are to be securely fastened and housed so as not to endanger the crew.
- (d) Gunwhale (Single Hull Canoes Only) - The measurements need to be 37 x 37mm (min) timber from bow to transom. To be an approved timber (i.e. Australian hardwood) alternatively, fiberglass gunwales of same strength are permitted.
- (e) Keel - Optional but if fitted shall be a min of 15mm thick
- (f) Leading Edge Radii - For keels rudders bows etc, shall be min of 3mm
- (g) Bailing Device (Single Hull Canoes Only) - A bailing device is to be carried at all times.

12.11.4. Minimum Weight

- (a) The minimum weight for a surf canoe is to be 80kg, excluding pump and batteries.

12.11.5. Rescue Tube - A rescue tube is to be carried at all times. Please referee to section 15.0 for Rescue Tube specifications.

12.11.6. Canoe Paddles

- (a) A canoe paddle is defined as a single bladed paddle. Paddles can be made of wood, fiberglass/carbon fibre or plastic- it is permitted to have an aluminum shaft.
- (b) There are no restrictions around the length of the paddle or the width of the blade. Please note: as defined above- ski paddles cannot be used in any sls canoe events.

12.12. BATON (Beach Relay/Beach Flags):

- 12.12.1. Beach flag batons and beach relay batons shall be made of flexible material (e.g., flexible hose) a maximum of 300 mm and a minimum of 250 mm long with an external diameter of approximately 25 mm (± 1 mm). Batons should be coloured so as to be easily visible.

12.13. COMMUNICATION AND VIDEO DEVICES ON SLS EQUIPMENT:

- 12.13.1. Communication and Video Devices on Surf Board, Skis and Double Hull Canoes:

- (a) The use of communication devices is NOT permitted by competitors from commencement to completion of a race.
- (b) The use of one video camera (e.g. GoPro's style devices) is permitted on surf boards, surf skis and Double Hull Canoes provided it is installed on a mounting device and toggle strap supplied or recommended by the manufacturer of the device.
- (c) Installation on 3.2m Racing Surf boards shall be approximately midway between the handgrips closest to the nose and the nose of the craft.
- (d) Installation on single and double skis shall be in front of the foot well.
- (e) The weight of any plugs permanently installed into the craft to attach the video camera shall be included in the overall weight of the craft.
- (f) The weight of other (non-permanently installed) mounts and camera are NOT to be included in the overall weight of the craft.
- (g) Installation on double hull canoes shall be in front of the foot well or on the back or front cross beam.

- 12.13.2. Communication and Video Devices on Surf Boats and Single Hull Canoe:

- (a) Competitors (attached either to a craft or to their person) do NOT permit the use of communication devices from commencement to completion of a race in Championship

competition.

- (b) With the exception of Boat Sweeps the use of a video camera attached to any part of a competitor is not permitted from the commencement of, to the completion of a race.
- (c) The use of video cameras (e.g. GoPro's style devices) on Surf Boats is permitted provided they are installed on a mounting device and toggle strap supplied or recommended by the manufacturer of the device.
- (d) Installation shall be permitted on the splash board (front deck), on the tank opposite the stroke's seat (No.4) and rear deck.
- (e) The weight of any plugs permanently installed into the boat to attach the video camera shall be included in the overall "bare weight" of the boat.(d) The weight of other (non-permanently installed) mounts and camera are not to be included in the overall "racing weight" of the craft.
- (f) A Surf Boat Sweep (only) is also permitted to have a video camera on a helmet, worn by them, provided that the camera is installed on a mounting device and toggle strap supplied or recommended by the manufacturer of the device.

12.13.3. Communication and Video Devices on Inflatable Rescue Boat (IRB):

- (a) The use of communication devices is NOT permitted by competitors (either attached to a craft or to their person) from commencement to completion of a race in Championship competition.
- (b) The use of one video camera (e.g. GoPro's style devices) is permitted on an IRB Engine provided it is installed on a mounting device and toggle strap supplied or recommended by the manufacturer of the device.
- (c) Installation on an IRB shall be located on the top face of the Engine cowling only.
- (d) The use of a video camera on crewperson or patent(s) attached to any part of a competitor is not permitted from the commencement of, to the completion of a race.
- (e) The IRB Driver is only permitted to have a video camera

on a helmet, worn by them, if the camera is installed on a mounting device and toggle strap supplied or recommended by the manufacturer of the device.

- 12.13.4. Reference: SLSNZ Sport Policy Statement – SS005, Communication and Video Devices on Surf Life Saving Equipment

12.14. FACILITY STANDARDS AND SCRUTINEERING PROCEDURES:

12.14.1. Pool Facility Standards

- (a) All Lifesaving World Championships shall be conducted in an eight-lane (minimum) 50 m swimming pool which complies with ILS standards. Facility measurements must be certified by a surveyor appointed or approved by the ILS Management Committee.

12.14.2. Scrutineering procedure

- (a) For ILS-managed events (e.g., Lifesaving World Championships, World Games), a person appointed by the ILS Management Committee shall review a pool survey certificate (or similar) that specifies:
- (b) pool length, width, depths, lane widths and ropes, starting platforms, electronic timing equipment, etc.
- (c) In the absence of such a certificate, the person appointed by the ILS Management Committee shall check that the pool facility meets ILS facility standards. In addition, the following equipment shall be checked:
- (i) obstacles, rescue tubes, throw lines, manikins
 - (ii) manikin platforms (including a depth check to ensure the platform is not too shallow).
 - (iii) Minimum measuring equipment required tape measure (minimum 50 m with 1 mm increments; depth rod or pole).
 - (iv) For ILS-sanctioned events, the sanction application requires a declaration from the competition organisers that the pool and all equipment to be used in the competition meets ILS standards.

- 12.14.3. Length - The pool shall be 50 m between the automatic officiating equipment touch panels at the starting end and the wall or touch panels at the turning end. A tolerance of plus 30 mm and minus 0.00 mm in each lane is allowed.
- 12.14.4. Lanes - There shall be a minimum of eight lanes that shall be at least 2.5 m wide, with two spaces of at least 200 mm outside the first and last lanes. There shall be lane ropes on both sides of each lane that extend the full length of the course. Each lane rope will consist of floats placed end-to-end having a minimum diameter of 50 mm to a maximum of 150 mm. The lane ropes shall be firmly stretched.
- 12.14.5. Starting platform - The height of the platform above the water surface shall be from 500 mm to 750 mm. The surface area shall be at least 500 mm x 500 mm and covered with non-slip material. The maximum slope shall not be more than 10 degrees. The starting platform may have an adjustable setting back plate and starting grips for both platform and in-water starts. If necessary any exposed ends on starting grips, etc. should be covered.
- 12.14.6. Automatic officiating equipment - The pool shall be equipped with automatic officiating equipment to record the time of each competitor and to determine the place of each competitor in race events.
- 12.14.7. Water - The pool water shall meet the clarity standards and the bacteriological and chemical standards of the applicable local health regulations in the host nation. The water temperature shall be 25 to 28 degrees Celsius.
- 12.14.8. Depth - For each event conducted, the pool shall comply with ILS event-specific depth standards. Except as specified in event-specific standards, a minimum depth of 1.0 m is required.
- 12.14.9. Dive start - Minimum depth of 1.35 m extending from 1.0 m to at least 6.0 m from the starting end wall.

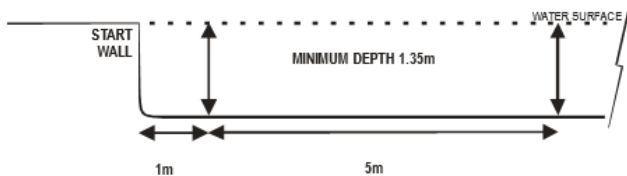

- 12.14.10. Obstacle Swim, Obstacle Relay - Minimum depth of 1.8 m extending from 2.0 m on both sides of any obstacle.

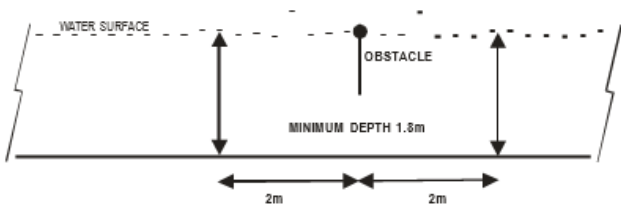

- 12.14.11. Manikin Carry (50 m), Super Lifesaver (200 m) - Minimum depth of 1.8 m extending at least 2.0 m beyond the 24 m mark from the wall. Manikins are placed on the pool bottom to a maximum depth of 3.0 m. In pools deeper than 3.0 m, “platforms” may be used to hold manikins at the 3.0 m depth.

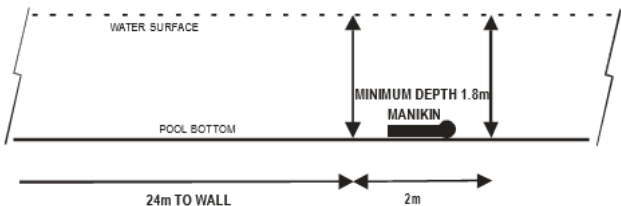

- 12.14.12. Manikin Carry with Fins (100 m), Manikin Tow with Fins (100 m), Super Lifesaver (200 m)
- (a) Minimum depth of 1.8 m extending at least 2.0 m from the turn wall.

- (b) Manikins are placed on the pool bottom to a maximum depth of 3.0 m. In pools deeper than 3.0 m, “platforms” may be used to hold manikins at the 3.0 m depth.
- (c) In the Manikin Carry with Fins event, the manikin shall be positioned on its back in contact with the pool bottom and its base touching the pool wall, with its head in the direction of the finish.
- (d) Where the facility design does not provide a vertical wall that joins the bottom at 90 degrees, the manikin must be positioned as close as possible to the wall, but no further than 300 mm from the wall as measured at the water surface.

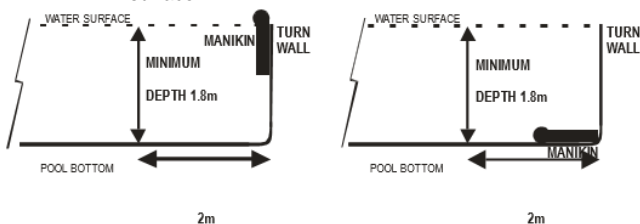

- 12.14.13. Rescue Medley (100 m) - Minimum depth of 1.8 m extending at least 2.0 m beyond the 16.5 m mark from the turn wall. Manikins are placed on the pool bottom to a maximum depth of 3.0 m. In pools deeper than 3.0 m, “platforms” may be used to hold manikins at the 3.0 m depth.**

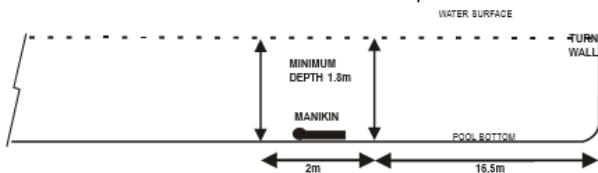

12.14.14. Manikin Relay (4 x 25 m)

- (a) Minimum depth of 1.8 m extending at least 2.0 m on both sides of the 25 m exchange mark at centre pool.
- (b) Minimum depth of 1.0 m at the starting end wall.
- (c) Minimum depth of 1.8 m extending at least 2.0 m from the

turn wall.

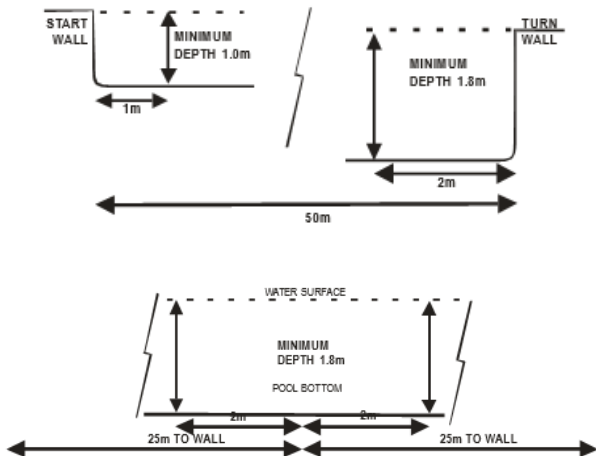

12.14.15. Medley Relay (4 x 50 m)

- Minimum depth of 1.35 m, extending from 1.0 m to at least 6.0 m from the starting end wall.
- Minimum depth of 1.8 m, extending at least 2.0 m from the turn wall.

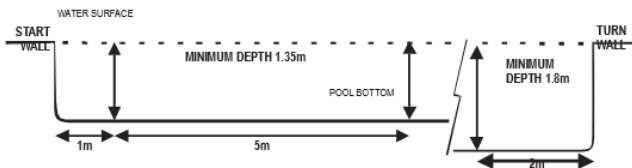

12.14.16. Line Throw

- Minimum depth of 1.8 m extending at least 2.0 m from the rigid crossbar.
- The rigid crossbar is positioned on the surface across each lane 12.5 m from the starting end of the pool. A tolerance of plus 100 mm and minus 0.00 mm in each lane is allowed.

- 12.14.17. Simulated Emergency Response Competition (SERC) - SERC may be conducted in the eight-lane 50 m pool or in a facility of another design, as approved by the ILS Management Committee.

12.15. RESCUE MANIKINS:

12.15.1. Construction and composition

- (a) Manikins are to be constructed of PITET type plastic and must be hermetic (i.e., capable of being filled with water and sealed for competition).
- (b) Material – Polyethylene
- (c) Colour – Orange
- (d) Transverse line – needs to be of contrasting colour with the rest of the manikin and water.
- (e) Thickness – 944 Kg./m²
- (f) Fluidity Index – 3 Dg/min

12.15.2. Mechanical properties of materials

- (a) Coefficient of Elasticity – 1000 N/mm²
- (b) Shock resistance Izod at +23 degrees Celsius – 19 kj/m²
- (c) Shock resistance Izod at -20 degrees Celsius – 6 kj/m²
- (d) Breaking resistance (ESCR) at 60aC N/mm² – 40
- (e) Traction resistance at 50mm/min. – 31 N/mm²
- (f) Breaking point in lengthening at 50 mm/min. – >500%
- (g) Hardness Shore D – 57
- (h) Vicat Point of softening – 121 Celsius
- (i) Fusion temperature – 128 Celsius

12.15.3. Technical measurement and weight specification

- (a) Total height – 1000 mm (980-1000 mm, 2% variance)
- (b) Height under armpit – 595 mm (585-595 mm, 1.7% variance)
- (c) Height transition line – 550 mm (540-550 mm, 1.9% variance)
- (d) Width at base – 260 mm (250-260 mm, 4% variance)
- (e) Depth at base – 200 mm (190-200 mm, 5.3% variance)

- (f) Circumference of head at eyes – 590 mm (570-590 mm, 3.5% variance)
- (g) Circumference of breast under arms – 800 mm (780-800 mm, 2.6% variance)
- (h) Circumference of base 1 cm from bottom – 840 mm (820-840 mm, 2.4% variance)
- (i) Weight in water completely submerged – 1500 g (1450-1500 g, 3.4% variance)

12.15.4. Physical features

- (a) The manikin must resemble a human and possess anthropological features that are required for rescue and resuscitation. The head requires the following features: eyes, nose, mouth, chin, jaw, and throat. The body requires a chest, torso arm buds, abdomen, and pelvis.
- (b) For events in which the manikin is recovered from the bottom, the manikin needs to rest on its back at 2.0 m depth without moving. The manikin needs to be able to rest in this position for a period of 4 hours without leaking water or air. If the manikin has filling holes and plugs, these should be located for ease of filling and emptying and be water and air tight. The manikin weight should be located such that it keeps the manikin positioned on its back.
- (c) The manikin needs to be able to float at the transition line for use in manikin towing events.

12.15.5. Scrutineering procedure

- (a) For ILS-managed events, a person appointed by the ILS Management Committee shall check the approved manikin. Minimum measuring equipment required tape measure (minimum 10 m with 1 mm increments); weigh scale (minimum 200 kg capacity with 1.0 g increments).
- (b) For ILS-sanctioned events, the sanction application requires a declaration from the competition organisers that all equipment to be used in the competition will meet ILS standards.

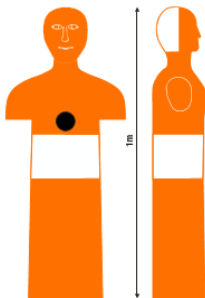

12.16. OBSTACLES:

12.16.1. Dimensions:

- (a) Obstacles used in pool events shall be 700 mm (± 10 mm) high and 2.4 m (± 30 mm) wide with no dangerous parts.

12.16.2. Inner frame:

- (a) The inner frame shall consist of a net or other element which does not permit passage by a swimmer, and which is of a bright colour, which contrasts with the water and is clearly visible.

12.16.3. Upper line:

- (a) The upper line of the obstacle is placed on the water level and shall be clearly visible. Use of an additional floating line across the upper line of the obstacles is recommended.

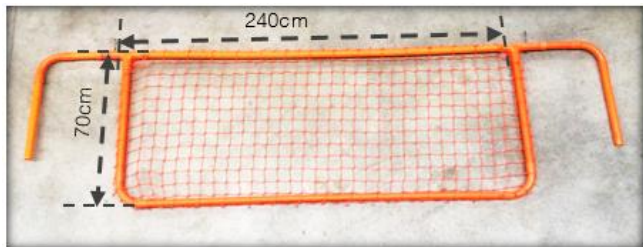

12.16.4. Scrutineering procedure

- (a) For ILS-managed events, a person appointed by the ILS Management Committee shall check the obstacles. Minimum measuring equipment required tape measure (minimum 10 m with 1 mm increments).
- (b) For ILS-sanctioned events, the sanction application requires a declaration from the competition organisers that all equipment to be used in the competition will meet ILS standards.
- (c) Note: If you are building obstacles for training purposes and these are not going to be used for competition then make sure you measure the lane width of the pool you will be training at prior to building your obstacle as lane width's vary.

12.17. RESCUE TUBES:

12.17.1. Construction and composition

- (a) Source of buoyancy: Material to be as specified in Australian Standard AS2259 or equivalent. The material shall be closed cell plastic foam, and durable and flexible.
- (b) Buoyancy: The rescue tube shall have a minimum buoyancy factor of 100 newtons in fresh water.
- (c) Flexibility: The body of the rescue tube shall be of such a nature as to be able to roll within itself with a force of 5-6 kg.
- (d) Strength: Webbing, leash, and fittings shall be able to withstand a minimum of 454.55 kg (1000 lb.) stress in a longitudinal direction without damage.
- (e) Weight: Total weight of the tube should be between 600-750 g.
- (f) Colour: The body of the rescue tube shall be a colour-fast red, yellow, or orange (impregnated, painted, or covered) as per Australian Standard AS1318.
- (g) Stitching/thread: Stitching shall be a locked stitched type 301 of British Standard BS 3870 as illustrated in Australian Standard AS2259. The thread is to have similar properties to the materials being sewn.

12.17.2. Technical measurements specification

- (a) Rescue Tube Dimensions: The body of the tube (flotation component):
- (b) L – minimum length 875 mm; maximum length 1000 mm
- (c) B – maximum breadth 150 mm
- (d) T – maximum thickness 100 mm

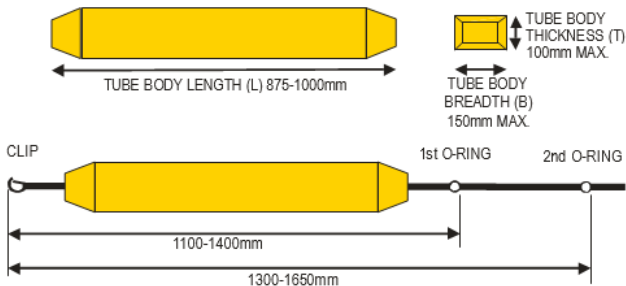

- (e) The distance from the extremity of the clip to the extremity of the first O-ring shall be a minimum of 1.10 m to a maximum of 1.40 m.
- (f) The distance from the extremity of the clip to the extremity of the second O-ring shall be a minimum of 1.30 m to a maximum of 1.65 m.

12.17.3. Leash/line:

- (a) The length of the leash from the first O-ring to the lanyard webbing shall be a minimum of 1.90 m to a maximum of 2.10 m, and must include a minimum of 2 O-rings. The leash shall be a synthetic type rope which is UV treated.

12.17.4. Webbing connections:

- (a) Webbing used for the connection of O-rings/clips to the body of the tube shall be 25 mm (± 2.5 mm) wide woven nylon.

12.17.5. Lanyard/harness:

- (a) Webbing for the lanyard shall be 50 mm (± 5.0 mm) wide woven nylon with a minimum length of 1.30 m to a

maximum of 1.60 m. The circumference of the lanyard loop shall be a minimum of 1.20 m.

12.17.6. O-rings:

- (a) O-rings shall be brass, stainless steel (welded) or nylon. If nylon, the rings shall be UV treated. O-rings shall be 37.5 mm ID (± 10.0 mm) in diameter, having no sharp edges or protrusions that may cut or injure the rescuer or victim.

12.17.7. Clips:

- (a) The clip shall be a brass or stainless steel snap hook KS2470-70 with an overall length of 70 mm (± 7.0 mm). It shall have no sharp edges or protrusions that may cut or injure the rescuer or victim.

12.17.8. Overall length:

- (a) The distance from the clip to the end of the lanyard/harness shall be a minimum of 3.65 m to a maximum of 4.30 m.

12.17.9. Scrutineering procedure

- (a) For ILS-managed events, a person appointed by the ILS Management Committee shall check the rescue tubes. Minimum measuring equipment required: tape measure (minimum 10 m with 1 mm increments).
- (b) For ILS-sanctioned events, the sanction application requires a declaration from the competition organisers that all equipment to be used in the competition will meet ILS standards.





12.18. SWIM FINS:

12.18.1. Fins are measured while not worn. Swim fins used in competitions shall comply with the following specifications:

- (a) Length: maximum overall length 650 mm, including 'shoe' or ankle strap (ankle strap extended).
- (b) Width: 300 mm maximum at the widest point of the blade.
- (c) Fins that do not comply with these provisions or could endanger other participants' health are not permitted in competition.
- (d) All competitors in U11, U12, U13 and U14 events are not eligible to use the "fiberglass or rocket" type of fin in any

event including the mega relay. All fins used by these age groups shall comply with the above specifications.

- (e) All competitors in U15 events are not eligible to use the “rocket” type of fin in any event including the mega relay. All fins used by these age groups shall comply with the above specifications.
- (f) Fin examples for Age Groups:

| Explanation | Fins |
|--|---|
| <p>Not Allowed: U8, U9, U10, U11, U12, U13, U14, U15</p> <p>Allowed: U17, U19, Open, Masters</p> <p>Rocket Fin: Blade made of fibre glass / carbon fibre reinforced plastic (angled ankle).</p> |  |
| <p>Not Allowed: U8, U9, U10, U11, U12, U13, U14</p> <p>Allowed: U15, U17, U19, Open, Masters</p> <p>Saver Fin: Fin blade made of fibreglass / carbon fibre reinforced plastic rubber fins.</p> |  |
| <p>Allowed: All ages</p> <p>Pool or Ocean Fins: Closed foot piece rubber fins.</p> |  |
| <p>Allowed: All ages</p> <p>Pool or Ocean Fins: Heel band.</p> |  |

SWIM FINS

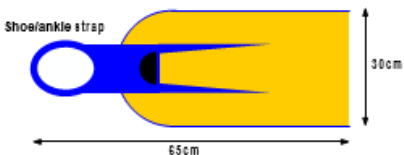

12.18.2. Scrutineering procedure

For ILS-managed events:

- (a) A person appointed by the ILS Management Committee shall check the fins at the pool and/or beach. Minimum measuring equipment required: tape measure (minimum 10 m with 1 mm increments), or; a fin box in which the fins are fully inserted, or; another measurement tool for quick and efficient measurement.
- (b) The Event Organiser shall provide a stamp or sticker to be affixed to the fins as proof of the scrutineering check.
- (c) A similar process shall be undertaken for ILS-sanctioned events.

12.19. THROW LINES:

12.19.1. For the Line Throw event, throw lines shall be plaited, buoyant polypropylene with non-memory characteristics: (rope specification: YP8 Lite line 8mm)

- (a) Diameter: 8 mm (± 1 mm)
- (b) Length: minimum 16.5 m; maximum 17.5 m



12.19.2. Scrutineering procedure

- (a) For ILS-managed events, a person appointed by the ILS Management Committee shall check the throw lines. Minimum measuring equipment required: tape measure (minimum 20 m with 1 mm increments).
- (b) For ILS-sanctioned events, the sanction application requires a declaration from the competition organisers that all equipment to be used in the competition will meet ILS standards.

12.20. RESCUE BRICKS:



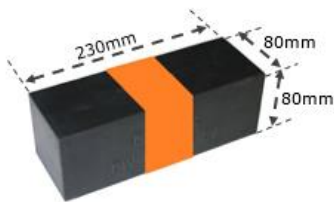



- (a) Weight: 3.5kg Rubber Dive Bricks
- (b) Measurements: 230mm x 80mm x 80mm
- (c) The rescue brick is to have a contrast colour line with the pool centre line.







12.21. SWIMWEAR:

12.21.1. Swimwear for both SLSNZ pool and ocean events must comply with the following standards:

- (a) Swimwear worn by males shall not extend above the navel or below the knee.
- (b) Swimwear worn by females shall not cover the neck, shoulders or arms nor extend below the knees. Two-piece swimsuits that conform to this standard may also be worn.

| Male Swimsuits | | | | | |
|---|---|---|---|---|---|
| Full Length | Long | Long Legs | Knee length | Square Leg | Short |
| Not Allowed | Not Allowed | Not Allowed | Allowed | Allowed | Allowed |
|  |  |  |  |  |  |

| Female Swimsuits | | | | |
|---|---|---|---|---|
| Full Length | Zippered Back | Knee Length, Open Back | Short, Open Back | Two Piece |
| Not Allowed | Not Allowed | Allowed | Allowed | Allowed |
|  |  |  |  |  |

12.21.2. The material and construction used in swimwear to be worn in all ILS pool and ocean events shall be:

- Only textile woven fabric(s) shall be permitted.
- Non-woven and/or non-permeable (e.g., wetsuit type) materials shall not be permitted.
- The material used shall have a maximum thickness of 0.8 mm.
- Other than string ties for the tops of men's swimwear or the bottom of female two-piece swimwear, no zippers or other fastening systems shall be permitted.
- The swimsuit worn by competitors shall not aid in their buoyancy.
- Swimwear that provides flotation, pain reduction, chemical/medical stimulation or other external stimulation or influence of any type shall be prohibited.
- No outside application on the material shall be permitted. (Note: manufacturer brandings, club names or similar are permitted).
- Competitors are not required to wear their club competition beanies while competing in SLSNZ Pool events.

- (i) For the line throw, competitors shall wear togs, clothing or dress as approved by SLSNZ, Board shorts and T-shirts will not be permitted. Exceptions to this rule must be approved by the Event referee

12.22. HIGH VISIBILITY VEST SPECIFICATIONS

12.22.1. Clarification of what is required for the 2016/17 season:

- (a) As set out in the Surf Sport Competition Manual, it is mandatory for all competitors to wear high visibility vests in competition (excluding pool-based events and IRB Events).
- (b) Note: With the introduction of mandatory Lifejackets to IRB racing and training then high visibility vests are not required while wearing a lifejacket (refer to policy SPS010 for full details)
- (c) It is also highly recommended that all members wear high visibility vests in training or activities in open water environments deeper than knee level.

12.22.2. Technical Colour Standards:

- (a) To avoid any doubt about whether a colour is 'high visibility' or not, specific PMS colour standards have now been identified, as set out below.
- (b) Also, for the 2016/17 season and beyond the colour highly recommended above all others is Fluorescent Yellow. (PMS #13-0630 TN 'Safety Yellow')
- (c) If for some reason this is not suitable, the other recommended colours are:
 - (i) Fluorescent Pink (PMS #16-2130 TN 'Knockout Pink')
 - (ii) Fluorescent Green (PMS#13-0340 TN 'Green Gecko')
 - (iii) Fluorescent Red (PMS#485C)
- (d) It is requested that from 2016/17 clubs do not use Fluorescent Orange (PMS# 15-1360-TN 'Shocking orange') as this will be used by Event Safety Teams for in-water searches.

12.22.3. Responsibilities:

- (a) SLSNZ has in place a 'guidelines for safety vests' based on a 'singlet' style of design that clubs can refer to (available on the SLSNZ website). Please note it remains the clubs responsibility that the vests they supply their athletes are 'fit for purpose' (i.e. high visibility assist with competitor identification when in the water).
- (b) This is particularly important for junior members where there is a higher duty of care required.
- (c) Equally, if any event organisers are supplying vests then they will be the ones ultimately accountable of the 'fitness for purpose'.
- (d) Short sleeve and long sleeve rash tops may also be worn as long as they meet the technical specifications above.

12.22.4. Ruling on vest standards

- (a) Perhaps most importantly, Surf Officials will still not be asked to make calls on the start line as to the 'fitness for purpose' of high visibility vests being worn by athletes unless they are clearly not high visibility or not wearing a vest at all.
- (b) This is because of the impracticality of surf officials measuring the area of fluoro material and its brightness. As such, to repeat the message above, the responsibility for 'fitness for purpose' rests back with whoever supplies the vests to the athletes – typically their club or in a few cases the event organisers.
- (c) Officials will be asked to report any concerns of vest standard of clubs to SLSNZ to complete a discussion with that club on their vest standards.

12.22.5. Vest Branding

- (a) There is still a desire by SLSNZ and clubs to at the least have the opportunity to put sponsor logos on the vests (without compromising their safety role). Below is an extract from the guidelines document – the actual document has larger imagery so the dimensions are easier to read.
- (b) Front of Vest Branding
 - (i) SLSNZ Supplied

- Vest will normally be yellow
 - National partner logo (front centred – shown by logo example).
 - SLSNZ logo (Right Chest)
 - Secondary national partner logo (optional Left Chest).
- (ii) Club Supplied
- Club funder/sponsor logo (front centred – shown by logo example)
 - Club logo (Right Chest – in position where SLSNZ logo is on example).
 - Secondary club funder/ sponsor logo (optional Left Chest).
 - There no requirement to have an SLSNZ logo on a club vest.



- (c) Rear of Vest Branding – Option 1 (Square Logo Shape)
- (i) SLSNZ Supplied
- National partner logo (Rear Centred)
- (ii) Club Supplied
- Club funder/ sponsor logo (Rear Centred)

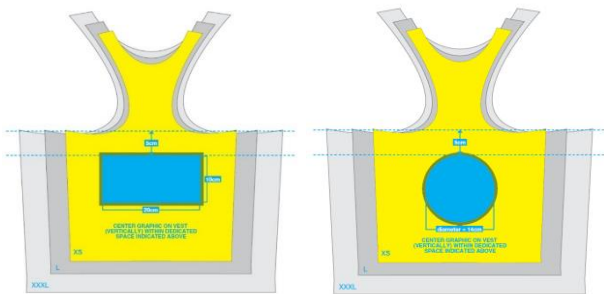

- (d) Rear of Vest Branding – Option 2 (Circular Logo Shape)
- (i) SLSNZ Supplied
 - National partner logo (Rear Centred)
 - (ii) Club Supplied
 - Club funder/ sponsor logo (Rear Centred)

12.22.6. SLSNZ Approach to High Visibility Vests

- (a) SLSNZ will continue to provide guidelines for those seeking advice;
- (i) As noted earlier, clubs will be solely responsible for the ‘fitness for purpose’ of the vests they supply their members;
 - (ii) Event organisers will be solely responsible for the ‘fitness for purpose’ of the vests they supply competitors;
 - (iii) Surf Officials will not be asked to make calls on the start line as to the ‘fitness for purpose’ of high visibility vests being worn by athletes. Their only role will be to assess whether a vest of some high visibility description is being worn or not.
- (b) The advantages of this are:
- (i) Flexibility for clubs;
 - (ii) It is in line with the approach clubs have asked SLSNZ to take on ‘Member Protection’ in general – whereby guidelines are provided to clubs rather than mandated actions.

- (iii) There is no need to develop a large manual of specifications for a wide variety of styles of vests that could be continuously challenged;
 - (iv) There is no need to set up a certification/ testing regime to validate the acceptability of each new club vest design;
 - (v) There are no additional pressure placed on Event Officials;
- (c) However, the responsibility that goes with this flexibility has to be seen to be taken seriously by clubs. If there is evidence that clubs are supplying vests that are not truly 'fit for purpose' or are not replacing them before they become too faded then SLSNZ may need to step in and mandate colours and dimensions.

12.23. BP INFLATABLE RESCUE BOAT (IRB):

12.23.1. The modifications to the listed equipment in this manual are the only modifications permitted to this equipment as received from the SLSNZ Approved Supplier / Manufacturer. All Suppliers / Manufactures must be SLSNZ approved.

12.23.2. Arancia 3.8m IRB

12.23.3. Transom Bracket

- (a) Transom bracket height will not exceed 430mm (factory standard). Measurement will be taken from the keel centre point of the lower transom to the top of the transom bracket. (Figure 1)
- (b) Original transom bracket must be fitted (as supplied when the IRB was purchased) or a subsequent Arancia approved replacement / upgrade (no modifications permitted).

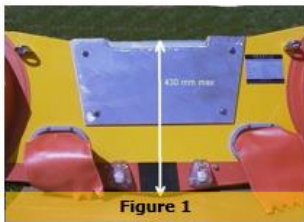

12.23.4. Floorboard fuel bladder fixtures

- (a) Floorboard fuel bladder fixtures must be as supplied by Arancia (factory standard). Figure 2
- (b) Should damage fixtures need to be replaced, correct positioning is required as per Figure 2

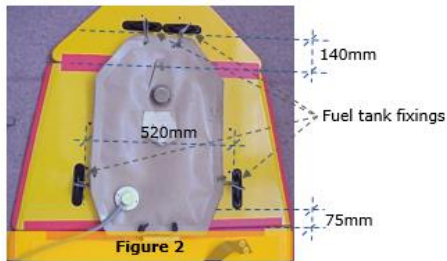

12.23.5. Engines

- (a) The Mercury 30M is the approved engine for SLSNZ competition.
- (b) All Engines must have SLSNZ “seals” intact and the powerhead must be in original condition i.e. a powerhead dismantled for repair is no longer eligible for use in SLSNZ competition. (Figure 3).
- (c) Air box may be drilled or relieved on the back but not on the front or sides
- (d) Thermostat may be drilled or removed
- (e) Accessory lighting coil may be removed
- (f) Spark Plug Connector Cap/leads may be replaced under normal maintenance with suitable substitutes
- (g) Water pump tell-tale outlet may be relocated to the opposite side
- (h) Ignition timing will not exceed SLSNZ specification
- (i) Approved SLSNZ stop switch may be fitted
- (j) Stop switch/button may be relocated to fuel bayonet connection position
- (k) Fuel bayonet connection may be relocated to the stop switch/button position
- (l) Tilt lock mechanism may be removed.

12.23.6. Pull Start Handle

- (a) Pull Start Handle will be as supplied with the engine with a maximum 130mm extension beyond the cowl cover exit.

(Figure 4)



12.23.7. Clamp Screws

- (a) These will be as supplied with the engine. (Figure 8)

12.23.8. Spark Plugs

- (a) Only the listed (manufacturer recommended) Spark Plugs may be used: Mercury = NGK B7HS-10 or NGK BR7HS-10

12.23.9. Engine Paint Colour

- (a) This must be the original manufacturers colour; only the top of the cowling cover is available for Sponsor/Club name, brand or logo. The front, back and sides of the cowling cover and engine tray/ trunk/gearbox must remain as supplied by SLSNZ complete with manufacturer's decals. (Figure 6)

12.23.10. SLSNZ Sponsor Branding

- (a) Anything displayed on an engine at time of purchase by the club must remain. (Figure 6)



12.23.11. Propellers

- (a) There is no restriction on propellers provided they comply with all clearances and requirements of SLSNZ approved propeller guards and the engine is fully operable under normal loading (Figure 7).

12.23.12. Propeller Guards

- (a) Propeller guards must be SLSNZ approved and must not be modified in any way from the manufacturer / supplier specification (excluding the screws / bolts / support plates attaching the propeller guard to the engine cavitation plate). The supplier of propeller guards is Stainless Design Ltd. (Figure 8)

12.23.13. Clearances

- (a) The leading and trailing propeller blade edges must be contained inside the ring guard (Figure 9 – Leading Prop Edge, Figure 10 – Trailing Prop Edge).

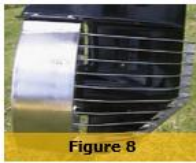

12.23.14. Engine Safety Strop

- (a) The engine safety strop must be SLSNZ approved and must not be modified in any way (including the use of heat shrink/tape/Velcro etc.) (Figure 11).
- (b) The safety strop must be fitted with a type 2470 (70mm x 31mm) stainless steel spring snap hook (Figure 12).
- (c) The safety strop may be supported by the engine gear lever at the start of the assembly rescue event.



Figure 11



Figure 12

12.23.15. Fuel

- (a) SLSNZ may provide fuel (petrol/outboard 2 stroke oil) for compulsory use in all engines competing in SLSNZ Competition.
- (b) Fuel will be BP 91 octane petrol or equivalent and high-grade mineral outboard oil.

12.23.16. Fuel Bladder

- (a) The following fuel bladders are approved for SLSNZ IRB competition.
- (b) Covertex 20 Litre
- (c) Covertex 15 Litre
- (d) Nauta 25 Litre
- (e) Wilsco 20 Litre

12.23.17. Fuel Bladder Clips

- (a) The type 2470 (70mm x 31mm) stainless steel spring snap hook is the only SLSNZ approved clip for use at SLSNZ Competition. (Figure 12).

12.23.18. Fuel Bladder Clip Attachment

- (a) The intention of fuel bladder clip fixture is to ensure no rigid type fixing that could expose the IRB crew to potential injury.
- (b) The fuel bladder must be fitted with 4 type 2470 (70mm x 31mm) stainless steel spring snap hooks (Figure 12) independently attached with rope to the eyelets or through the carry handles.
- (c) Rope type and diameter is not restricted but the rope length between the clip and bladder attachment point will be determined by allowing minimum travel of the fuel bladder

from its designated position.

- (d) The rope must be of sufficient strength to retain the fuel bladder during all manoeuvres.
- (e) The rope may be supported by the use of tape/heat shrink but this must not encroach onto the clip.
- (f) Clips must be attached to the fuel bladder in such a way as to allow a 180-degree rotation between the clip and the fuel bladder attachment point. (Figure 13 - Covertex & Figure 14 - Nauta)



12.23.19. Fuel Line / Bayonet Connection

- (a) The fuel line may have up to 100mm of 'support' where it connects to the bayonet. The measurement is inclusive of the bayonet. Any 'support' must not encroach onto the bayonet. (Figure 15)

12.23.20. Throttle Return Spring

- (a) All Mercury Surf Engines must be fitted with a functioning throttle return spring as issued by SLSNZ. (Figure 16)

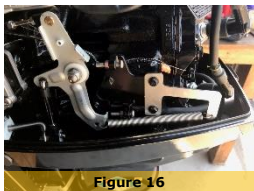

12.24. PERSONAL FLOTATION DEVICE (PFD):

12.24.1. PDF Operational Requirements

- (a) To be fit for Surf Lifesaving purposes, a PFD must be able to meet the following requirements:
 - (i) Be non-restrictive and streamlined for operational duties including swimming (25m in calm seas), lifting patients and moving in and around powercraft;
 - (ii) Be suitable for beach and surf conditions (durable to salt water and extreme UV conditions);
 - (iii) Be easy and quick to fit and remove;
 - (iv) Optional: Where the PFD is to be used for night time operations, it is to have reflective taping on the outside of the jacket;
 - (v) Optional: If required, have a securing point for a duty radio on the right collar bone area (Inherently buoyant PFD only).
 - (vi) Inflatable PFDs (manually activated and automatically activated) are not permitted in Surf Sports competition.

12.24.2. PFD Construction

- (a) PFDs must meet New Zealand Standard (NZS) 5823: 1999, NZ S5823. 2001, or NZS 5823: 2005 – specification for buoyancy aids. – Or another national standard substantially complying with the New Zealand standards. These include US, Australia, European and ISO standards.
- (b) Personal flotation devices level 50 is the minimum requirement.
- (c) The PFD is to be lightweight;
- (d) The PFD is to be non-obstructive to the throat, neck or face area;
- (e) The PFD must not have any sharp edges or materials that may cause injury to the user;
- (f) The PFD must be able to be secured as to prevent riding up;
- (g) Any fastening device/s on the PFD are to be fashioned in a way to not cause entanglement;

(h) The PFD is to be comfortable to wear.

12.24.3. The wearing of a high visibility colour on competitors lifejacket or addition vest otop is optional for drivers, crewperson and patients while wearing a PFD.



12.25. HELMETS:

12.25.1. Helmet Operational Requirements:

- (a) To be fit for surf lifesaving purpose, a helmet must be able to meet the following requirements:
- (i) Be non-restrictive and streamlined for operational duties including swimming (25m in calm seas), lifting patients and moving in and around powercraft;
 - (ii) Be suitable for beach and surf conditions (durable to salt water and extreme UV conditions);
 - (iii) Be easy and quick to fit and remove;
 - (iv) Be sized to fit the intended wearers head size.

12.25.2. Helmet Construction:

- (a) Helmets must meet CE 1385 standards for whitewater safety.
- (b) The helmet is to be lightweight (less than 600g)
- (c) The helmet does NOT feature a prominent peak, visor or flared brim projecting outwards from the shell.
- (d) The helmet has prominent and functional drainage/ventilation holes.
- (e) The helmet does NOT cover the ears without a functional device/design to enable hearing.

- (f) Helmet shell sizes are proportional to the intended wearers head size. (for example: child helmets must have a smaller shell circumference to adult helmets)
- (g) Surf Life Saving Australian approved helmets are accepted by Surf Life Saving New Zealand.



Example helmet pictures only

12.25.3. **SLSNZ Compliance:**

- (a) All equipment used in Surf Lifesaving New Zealand sanctioned events shall comply with the specifications contained in this manual.
- (b) Surf Boats, Surf Boards, Surf Skis and Surf Canoes shall display one of the following means of indicating compliance with the specifications:
 - (i) An SLSNZ approved craft sticker, or
 - (ii) An SLSA approved craft sticker.
- (c) IRB's shall be subject to recording of their compliance by the IRB scrutineer.
- (d) All other equipment, Junior Surf craft and pool equipment shall be exempt from the above but must comply with the specifications and will be subject to random scrutineering.

12.25.4. **Scrutineering:**

- (a) SLSNZ shall appoint a Chief Scrutineer and such assistant scrutineers as required to ensure compliance with the equipment specifications for events.
- (b) Scales and other equipment (jigs) necessary to ensure compliance shall be made available on the day preceding

major events to allow the checking of equipment and the issuing of compliance stickers for those requiring it. Scrutineering is optional to members to partake in but if requested by a scrutineer then athletes must comply with the request.

- (c) Random checking of equipment to ensure compliance may take place during and at the conclusion of the event.
- (d) At major events, top three finishers in finals should expect their gear to be scrutinized following their event (race). It is recommended that a club representative is also present also during the scrutineering process.
- (e) Persons found to be using equipment not complying with the specification shall be disqualified from the event (race) in which that equipment was used.
- (f) Every endeavor should be made to have Scrutineering equipment available at major events and a full list of events where SLSNZ will scrutineer equipment will be made available to clubs each year.

12.26. COMPETITION ARENA EQUIPMENT:

12.26.1. Surf Boat and Surf Canoe Straddle Line Elevation

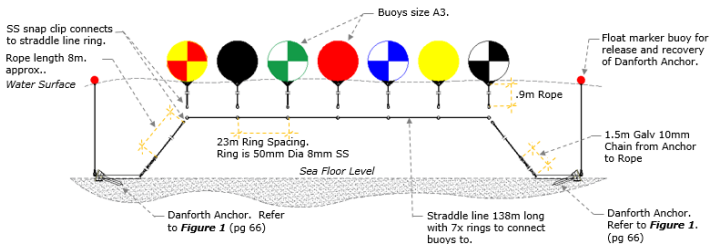

12.26.2. IRB Straddle Line Elevation

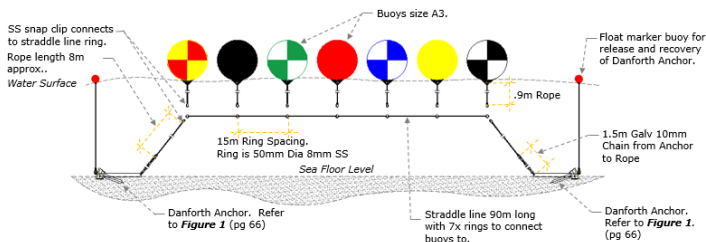

12.26.3. Swim/Tube/Board Rescue Straddle Line Elevation

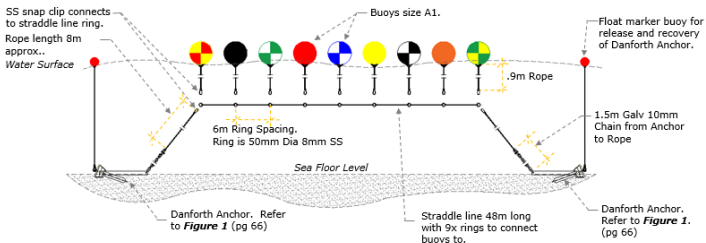

12.26.4. Straddle Line Tensioner Elevation

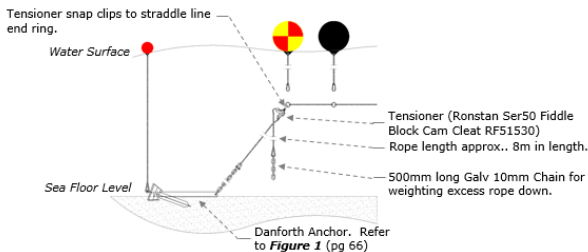

12.26.5. IRB Tube Rescue Straddle Lines Spacers Plan

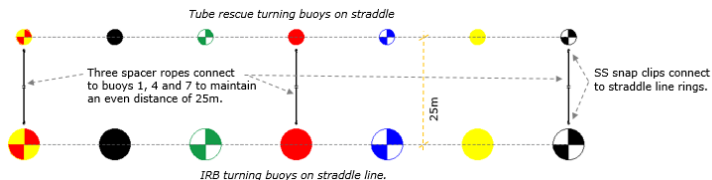

12.26.6. Individual Dropper Elevations

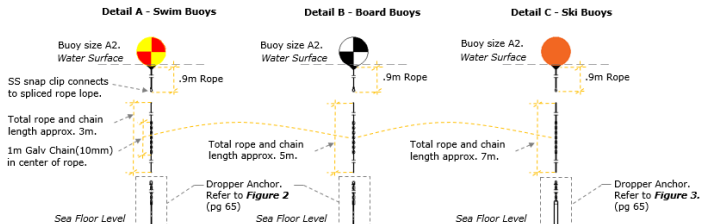

Note: The length of the chain and ropes is dependent on the depth of the sea floor. The measurement show above are approximate sizes that SLSNZ has found to be adequate on a number of beaches.

12.26.7. Individual Dropper Anchor Detail

Figure 2 – Small Dropper Anchor

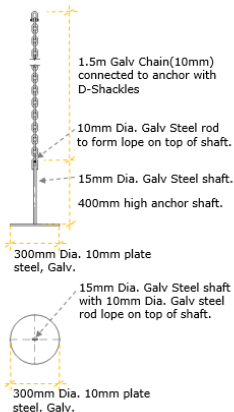
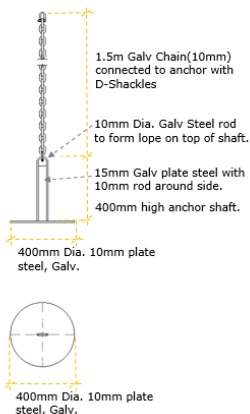
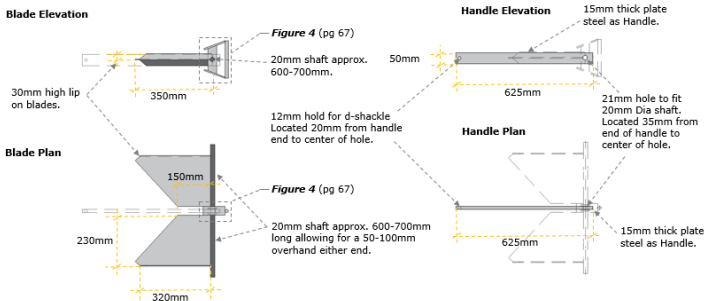

Figure 3 – Large Dropper Anchor



12.26.8. Danforth Anchor Details - Figure 1

- (a) The Danforth anchor is built in two main parts:
- (i) blades which swivel on
 - (ii) the handle.



12.26.9. Danforth Anchor Details Continues

Assembled Detail

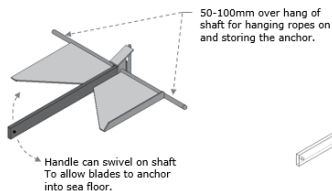

Construction Detail

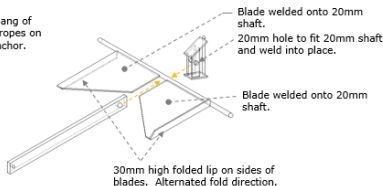
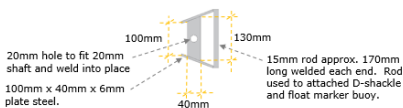
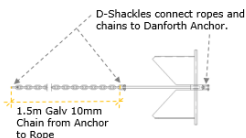

Figure 4



Connections Detail



12.26.10. Pole Stand Detail

Pole Stand Elevation

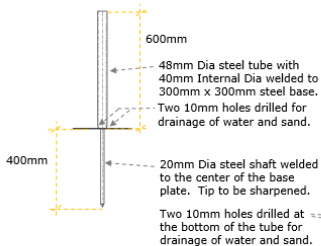



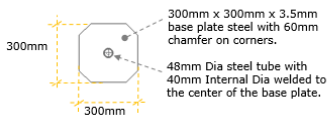

Pole Stand Plan

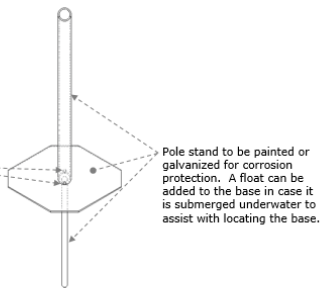



Pole Stand Constructed View



12.26.11. Fixings, Fasteners, Chain and Rope Specifications

| Item | Reference/Details | Size | Suppliers |
|---|---|-------------------------|--|
|  D-Shackle | Connecting buoys / anchors to rope / chain. | 10mm | www.bunnings.co.nz www.mitre10.co.nz www.anzor.co.nz |
|  Snap Clips | Stainless Steel Snap Clips, two types. | | www.bunnings.co.nz www.mitre10.co.nz www.anzor.co.nz |
|  Tensioner | Ronstan Ser50 Fiddle Block Cam Cleat | RF51530 | www.Burnsco.co.nz |
|  Rope | 3 strand Danline (Polyprop) | 10-12mm | www.Burnsco.co.nz |
|  Chain | 10mm Galv Chain | 10mm Chain | www.Burnsco.co.nz |
| Rings (Straddle Line) | Stainless steel rings spliced onto rope. | O/D 50mm I/D 42mm | www.anzor.co.nz Engineering manufacturers |
|  A1 Buoy | Swim straddle line buoys. | 300mm dia approx. | www.Burnsco.co.nz |
|  A2 Buoy | Board, Ski, Swim Buoys. | 400mm dia approx. | www.Burnsco.co.nz |
|  A3 Buoy | Surf Boat, Surf Canoe and IRB buoys. | 500mm dia approx. | www.Burnsco.co.nz |
| Float | Danforth Anchor float line. | Small size buoy / float | www.Burnsco.co.nz |

| | | | |
|--|---|---|--|
|  | | | |
| Start Line Poles (Detail 12.25.12) | Plastic conduit coloured bright orange. | 2 Meters long x 100mm Dia | www.bunnings.co.nz www.mitre10.co.nz www.marley.co.nz |
| Finish Line Poles (Detail 12.25.12) | Aluminium or galvanized steel | 4 Meters long x 25mm Dia | www.steelandtube.co.nz |
| Pole Base (Detail 12.25.10) | Detail 25.9 | Detail 25.9 | Engineering manufacturers |
| Beach Flag/Relay Baton  | Fire hose or similar in bright colours (red / yellow) | 300mm long, 25- 30mm dia Hose | |
| Buoys / Flags Colour Codes  | Blue/White Red/Yellow Red Orange Black/White Green Yellow Green/White Blue/Pink | Ink colour codes are to be confirmed | Suppliers to be confirmed |

12.26.12. Buoys, Poles and Flags Detail



12.26.13. Beach Flags Arena Detail

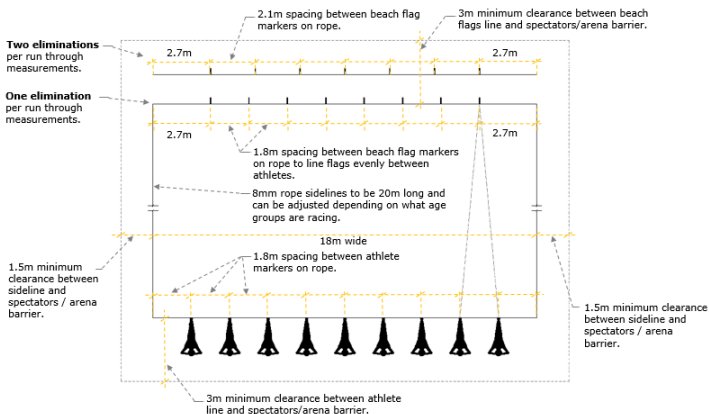

12.26.14. Beach Flags Arena Notes:

(a) Marking the Rope:

- (i) To mark the rope with beach flag positions or athletes start positions use heat shrink or crimps for a permanent mark attached to the rope.
- (ii) The marks need to be easily identified and in a colour that is different from the rope colour and sand. (e.g. Blue, Red, Green).
- (iii) It is also important to use different rope colours for start line, sidelines and finish line so they are identified easily when setting up the beach flags arena.

(b) Pegging the Sidelines, Start and Finish Lines: When laying out the arena follow these points so the arena is usable and square:

- (iv) Peg one sideline down in an area that has soft sand for the finish line. This may be running up the beach towards the sand dune or parallel to the sand dune / water. The sideline should be pegged with a peg at either end of the rope.

- (v) Peg the start or finish line starting from an end of the sideline at 90deg and peg down with a peg at either end. To make sure the ropes are 90deg you can measure a (3m x 4m x 5m) triangle in the corner.
- (vi) Do the same as point two with the remaining start or finish line and peg at either end.
- (vii) Finally peg the other sideline in with a peg at either end.
- (viii) When the competition is on you can then remove the start and finish lines as required once athletes are in place. (Note: it is important to remove the finish line to avoid athlete being tangled or injured landing on the rope. The start line can stay in place if required but an assessment should be made of the safety to athletes and the rope becoming a tripping hazard if the sand gouges out.



SURF LIFE SAVING[®]
NEW ZEALAND

In it for life